

CHAPTER 9
PO 309 – INSTRUCT A LESSON



COMMON TRAINING
PROFICIENCY LEVEL THREE
INSTRUCTIONAL GUIDE



SECTION 1

EO M309.01 – EXPLAIN THE PRINCIPLES OF INSTRUCTION

Total Time:

60 min

PREPARATION

PRE-LESSON INSTRUCTIONS

Resources needed for the delivery of this lesson are listed in the lesson specification located in A-CR-CCP-803/PG-001, Chapter 4. Specific uses for said resources are identified throughout the instructional guide within the TP for which they are required.

Review the lesson content and become familiar with the material prior to delivering the lesson.

The activity in TP 2 uses learning stations. Learning stations are a form of group work where the cadets learn by sorting through the information presented. When setting up learning stations, ensure there is enough room for each cadet to be comfortable and have adequate space for writing down information. When the cadets arrive at a learning station, all required information shall be available. These stations should be placed close together to minimize time for movement; however far enough apart to avoid interruptions from other groups. For this lesson, choose and set up six learning stations for the principles of instruction.

Photocopy the Principles of Instruction Information Sheets located at Annex A and the Principles of Instruction Worksheets located at Annex B for each station.

PRE-LESSON ASSIGNMENT

N/A.

APPROACH

An interactive lecture was chosen for TP 1 to present the principles of instruction and to generate interest.

An in-class activity was chosen for TP 2 as it is an interactive way for the cadets to apply the principles of instruction.

INTRODUCTION

REVIEW

N/A.

OBJECTIVES

By the end of this lesson the cadet shall have explained the principles of instruction and how they are applied when planning and instructing a lesson.

IMPORTANCE

It is important for the cadets to explain the principles of instruction and how they are applied when planning and instructing a lesson to make training enjoyable and successful and to help the instructor make informed decisions while in front of a class. The ability to keep a class interested, motivated and eager to learn are invaluable skills that will provide a positive learning experience for the cadets.

Teaching Point 1

Describe the Principles of Instruction

Time: 10 min

Method: Interactive Lecture

THE PRINCIPLES OF INSTRUCTION



Principle. A fundamental truth or law as the basis of reasoning or action.

In order to create an environment that promotes participation and learning, an instructor follows a set of guidelines or principles to plan and instruct a lesson. The following are the fundamental guidelines known as the principles of instruction:

- **Interest.** Cadets are more receptive to learning when they are curious and have an emotional connection to a topic. The instructor must arouse, create and maintain the interest of the cadets. Without interest, the cadets will be less inclined to listen and will not learn.
- **Comprehension.** Comprehension or understanding relates to the cadet's ability to understand the material taught. The cadets' readiness to learn new material is influenced by what has previously been taught; new content should not exceed the knowledge level of the cadets. If the cadets do not understand, they are unable to learn.
- **Emphasis.** During a period of instruction, there will be some information that may be of particular importance. The instructor can emphasize this important information through the use of voice control, training aids and in-class activities.
- **Participation.** Cadets are more likely to retain information if they are both mentally and physically involved in learning. The instructor should conduct activities that contain action, activity and excitement. Cadets learn by doing.
- **Accomplishment.** The lesson must impart a sense of accomplishment to each cadet. The cadets should leave the class with the satisfaction that they were able to accomplish something in the lesson.
- **Confirmation.** Confirmation is an essential part of learning and instructing. It gives both the instructor and the cadet the opportunity to see how well the information is understood.



The acronym ICEPAC is useful for remembering the principles of instruction.

CONFIRMATION OF TEACHING POINT 1

QUESTIONS

Q1. List the principles of instruction.

Q2. What will occur if a lesson lacks interest?

Q3. What is the acronym that can be used to remember the principles of instruction?

ANTICIPATED ANSWERS

A1. The principles of instruction are:

- interest,
- comprehension,
- emphasis,
- participation,
- accomplishment, and
- confirmation.

A2. Without interest the cadets will be less inclined to listen and will not learn.

A3. The acronym that can be used to remember the principles of instruction is ICEPAC.

Teaching Point 2

Conduct an Activity Where the Cadets Will Apply the Principles of Instruction

Time: 40 min

Method: In-Class Activity

ACTIVITY

OBJECTIVE

The objective of this activity is to have the cadets practice the application of the principles of instruction.

RESOURCES

- Principles of instruction information sheets,
- Principles of instruction worksheets, and
- Pens/pencils.

ACTIVITY LAYOUT

Set up six learning stations, to include:

- principles of instruction information sheets,
- principles of instruction worksheets, and
- pens/pencils.

ACTIVITY INSTRUCTIONS

1. Divide the cadets into six groups and place each group at one of the principles of instruction learning stations.
2. Assign each group a leader. Have the group leader assign a recorder and a reader.

- Using the principle and topic at the top of the page, have the groups fill out the principle of instruction worksheet (it is necessary for each group to fill out only one worksheet).
- After five minutes, have the groups rotate clockwise to the next station. Have the cadets complete the next principle of instruction worksheet.



Have the groups bring their worksheets with them as they rotate through the stations.



It is important to circulate around the room to facilitate the activities and help the cadets as required. If possible, assign other instructors to aid with supervision and facilitation.

- Rotate the groups through the remaining stations.
- Have the cadets share the information they recorded with the rest of the cadets. In most cases the groups will have recorded the same information for each station. If a group has listed different information it will be shared after the presentation is finished.

SAFETY

N/A.

CONFIRMATION OF TEACHING POINT 2

The cadets' participation in the activity will serve as the confirmation of this TP.

END OF LESSON CONFIRMATION

The cadets' participation in the principles of instruction learning stations will serve as the confirmation of this lesson.

CONCLUSION

HOMEWORK/READING/PRACTICE

N/A.

METHOD OF EVALUATION

N/A.

CLOSING STATEMENT

Describing the principles of instruction and knowing how to apply them when planning and instructing a lesson assists in making training enjoyable and successful and helps the instructor make informed decisions while in front of a class. The ability to keep a class interested, motivated and eager to learn are invaluable skills that will provide a positive learning experience.

INSTRUCTOR NOTES/REMARKS

The learning stations must be set up prior to beginning this lesson.

The cadets will be divided into six groups and will rotate through the stations during the in-class activity in TP 2.

REFERENCES

A1-041 A-P9-050-000/PT-006 Canadian Forces Individual Training and Education System. (1997). *Conduct of Instructional Programmes* (Vol. 6). Ottawa, ON: Department of National Defence.

THIS PAGE INTENTIONALLY LEFT BLANK



COMMON TRAINING
PROFICIENCY LEVEL THREE
INSTRUCTIONAL GUIDE



SECTION 2

EO M309.02 – IDENTIFY METHODS OF INSTRUCTION

Total Time:

60 min

PREPARATION

PRE-LESSON INSTRUCTIONS

Resources needed for the delivery of this lesson are listed in the lesson specification located in A-CR-CCP-803/PG-001, Chapter 4. Specific uses for said resources are identified throughout the instructional guide within the TP for which they are required.

Review the lesson content and become familiar with the material prior to delivering the lesson.

Photocopy Annexes C and D for each cadet.

PRE-LESSON ASSIGNMENT

N/A.

APPROACH

An interactive lecture was chosen for TP 1 to describe types of lessons as it allows the instructor to deliver new information while encouraging the cadets to actively participate by asking and responding to questions.

An in-class activity was chosen for TPs 2 and 3 as it is an interactive way to reinforce the topic and confirm the cadets' comprehension of types of lessons and methods of instruction.

INTRODUCTION

REVIEW

N/A

OBJECTIVES

By the end of this lesson the cadet shall have identified a method of instruction appropriate for a specific type of lesson and given topic.

IMPORTANCE

It is important for cadets to know that there are many methods of instruction that can be used for knowledge and skill lessons. Varying the method of instruction is one way for instructors to create interest and encourage learning.

Teaching Point 1**Describe Types of Lessons**

Time: 5 min

Method: Interactive Lecture

TYPES OF LESSONS

Knowledge and skill are the two types of lessons.



The main differences between a knowledge lesson and a skill lesson are how the cadets participate during the lesson and how the instructor confirms learning at the end of a teaching point or lesson.

In a knowledge lesson, the cadets participate by asking and responding to questions and discussing lesson content. The instructor confirms learning by posing questions to the class or conducting an activity.

In a skill lesson, the cadets participate by practicing and performing a skill while the instructor observes the cadets' performance to confirm learning.

Knowledge Lesson

A knowledge lesson gives the cadets the theoretical aspects of a subject. The instructor presents basic information about a topic, typically following the who, what, where, when and why (5 Ws) format. Delivering an effective knowledge lesson requires the instructor to:

1. select an instructional method;
2. research the lesson information thoroughly;
3. summarize the information;
4. prepare questions to encourage class participation;
5. prepare questions for confirmation; and
6. prepare training aids.



All lessons require the instructor to create and maintain interest. It is especially important that instructors ensure that knowledge lessons are interesting because they are not hands-on.

Skill Lesson

A skill lesson demonstrates the skill to be learned in a step-by-step sequence. Conducting an effective demonstration requires the instructor to:

1. plan carefully;
2. breakdown the skill to be taught into sequential steps;
3. rehearse the sequence to ensure that it is accurate and clear;
4. prepare a written lesson plan;
5. prepare and/or obtain all material needed to demonstrate and practice the skill in advance;

6. organize the class so the demonstration can be seen;
7. allow the cadets to practice the steps under supervision;
8. provide assistance or re-demonstrate as necessary; and
9. allow the cadets to continue to practice under supervision until all have achieved the skill.

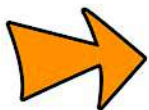

Mastery of a particular skill may require practice beyond class time depending upon the learners and difficulty of the skill.



Learning is a combination of knowledge, attitudes and skills that promote the development of a cadet.

CONFIRMATION OF TEACHING POINT 1

QUESTIONS

- Q1. What are the main differences between knowledge and skill lessons?
- Q2. How do instructors confirm learning in a skill lesson?
- Q3. Why is it more difficult to create and maintain interest in a knowledge lesson?

ANTICIPATED ANSWERS

- A1. Knowledge and skill lessons differ mainly in how cadets participate during the lesson and how instructors confirm learning at the end of a teaching point or lesson.
- A2. Instructors confirm learning in a skill lesson by observing the cadets perform the skill.
- A3. It is more difficult to create and maintain interest in a knowledge lesson because it is not hands-on.

Teaching Point 2

Conduct an Activity Where the Cadets Will Describe Methods of Instruction

Time: 25 min

Method: In-Class Activity

BACKGROUND KNOWLEDGE

INSTRUCTIONAL METHODS

Instructors should be familiar with and able to use a variety of methods of instruction. Some of the more widely used instructional methods are described and located at Annex C.

ACTIVITY

OBJECTIVE

The objective of this activity is to have the cadets describe methods of instruction.

RESOURCES

- Methods of instruction information sheets,
- Flip chart paper,
- Coloured markers, and
- Pens/pencils.

ACTIVITY LAYOUT

Set up four work stations and label them “description”, “pre-lesson preparation”, “typical applications” and “lesson development”. At each station have:

- three sheets of flip chart paper, and
- coloured markers.

ACTIVITY INSTRUCTIONS

1. Divide the cadets into four groups and place each group at one of the labelled work stations.
2. Give the cadets a copy of Annex C.
3. Assign each group a leader. The group leader will be responsible for assigning a recorder and reader.
4. Have each group research their information (description, pre-lesson preparation, typical applications, or lesson development) from Annex C for each method of instruction and record the key points on the flip chart paper. (10 minutes)
5. Have the groups share their information with the class. (10 minutes)

SAFETY

N/A.

CONFIRMATION OF TEACHING POINT 2

The cadets' participation in the activity will serve as the confirmation of this TP.

Teaching Point 3**Conduct an Activity Where the Cadets Will Select an Appropriate Method of Instruction for a Given Topic**

Time: 20 min

Method: In-Class Activity



The instructional method is determined by the:

- lesson material,
- environment in which the training will take place,
- resources available to the instructor,
- time available to the instructor, and
- needs of the cadets.

ACTIVITY**OBJECTIVE**

The objective of this activity is to have the cadets consider criteria and select an appropriate method of instruction for each topic.

RESOURCES

List of lesson topics located at Annex D.

ACTIVITY LAYOUT

N/A.

ACTIVITY INSTRUCTIONS

1. Give the cadets a copy of Annex D.
2. Introduce the objective of the activity and have the cadets work individually for 10 minutes matching the lesson topics to the instructional methods described in TP 2.
3. Stress that some topics can be taught using more than one method of instruction but they are to choose the one they consider to be the most appropriate.
4. Have the cadets share their work with the class by identifying and explaining their choice of instructional method for a topic.



No single instructional method is best for all objectives. Providing instruction using a variety of methods can often enhance learning.

SAFETY

N/A.

CONFIRMATION OF TEACHING POINT 3

The cadets' participation in the activity will serve as the confirmation of this TP.

END OF LESSON CONFIRMATION

QUESTIONS

- Q1. What is one application of the interactive lecture?
- Q2. How does the instructor confirm learning when using the demonstration and performance instructional method?
- Q3. What instructional method is being used when the cadets participate in "real life" operations that illustrate what was discussed or learned in the classroom?
- Q4. Give two examples of in-class activities?
- Q5. Games create variety and arouse interest. It is critical they do what?
- Q6. Which instructional method is being used when cadets produce a product, carry out an application or demonstrate a process?

ANTICIPATED ANSWERS

- A1. Interactive lectures can be used to review previously taught material, present background information, introduce a new subject, give instructions on procedures, illustrate the application of rules, principles or concepts and introduce a demonstration, discussion or performance.
- A2. During a demonstration and performance, the instructor confirms learning by observing the cadet perform the operation, skill or movement.
- A3. Field trip.
- A4. In-class activities include learning stations, videos, brainstorming, debating and group work.
- A5. It is critical that games support learning.
- A6. Practical activity.

CONCLUSION

HOMEWORK/READING/PRACTICE

N/A.

METHOD OF EVALUATION

This EO is assessed IAW A-CR-CCP-803/PG-001, Chapter 3, Annex B, Appendix 3 (309 PC).

CLOSING STATEMENT

Being able to select a method of instruction appropriate for a given lesson is an important skill for an instructor. Cadets will be more likely to pay attention, participate in classroom activities, answer questions and generally have a positive learning experience if instructors select an appropriate instructional method and plan the learning activities.

INSTRUCTOR NOTES/REMARKS

N/A.

REFERENCES

- A1-041 A-P9-050-000/PT-006 Director Training and Education Policy. (2002). *Canadian Forces Individual Training and Education System* (Vol. 6). Ottawa, ON: Department of National Defence.
- A1-042 A-P9-050-000/PT-005 Director Training and Education Policy. (2001). *Canadian Forces Individual Training and Education System* (Vol. 5). Ottawa, ON: Department of National Defence.

THIS PAGE INTENTIONALLY LEFT BLANK



**COMMON TRAINING
PROFICIENCY LEVEL THREE
INSTRUCTIONAL GUIDE**



SECTION 3

EO M309.03 – DESCRIBE EFFECTIVE-SPEAKING TECHNIQUES

Total Time:

30 min

PREPARATION

PRE-LESSON INSTRUCTIONS

Resources needed for the delivery of this lesson are listed in the lesson specification located in A-CR-CCP-803/PG-001, Chapter 4. Specific uses for said resources are identified throughout the instructional guide within the TP for which they are required.

Review the lesson content and become familiar with the material prior to delivering the lesson.

PRE-LESSON ASSIGNMENT

N/A.

APPROACH

An interactive lecture was chosen for TPs 1 and 3 to present basic material and to orient the cadets to aspects of voice control and how to prepare for effective-speaking.

A group discussion was chosen for TP 2 as it allows the cadets to interact with their peers and share their knowledge, experiences, opinions and feelings about physical presence while speaking in front of a group.

INTRODUCTION

REVIEW

N/A.

OBJECTIVES

By the end of this lesson the cadet shall have described elements of voice control, elements of physical presence and effective-speaking preparation.

IMPORTANCE

It is important for the cadets to describe elements of voice control and physical presence to be a confident instructor. The ability to effectively prepare for a presentation and control nervousness are invaluable skills that help to provide a positive learning experience for both the instructor and the trainee.

Teaching Point 1**Explain Elements of Voice Control**

Time: 10 min

Method: Interactive Lecture



The cadets may have been exposed to people from other communities, provinces and even countries with accents different from their own. Brainstorm with the cadets how elements of voice control can affect how the message is received and write down the responses. After the brainstorming is complete, compare the class list to the list below.

ELEMENTS OF VOICE CONTROL

One of the most important and effective tools of communication is voice control. The ability to use voice control to communicate effectively and place emphasis on important information is a fundamental skill that will be used while in front of an audience.

Pitch. How high or low a voice is. A change in pitch usually does not add any significance to a message. However, a pitch change will be noticed by the audience and will keep people involved.

Tone. The quality of the sound of a voice. Effective communicators will often change the tone of their voice to give emphasis to a single word or phrase to convey emotion and conviction.



Monotone. A sound without change of pitch or tone.

Volume. The quantity or power of sound or fullness of tone. A change in volume often signifies emphasis on a particular phrase or point. Environmental factors such as outside noise and room size must be taken into consideration to ensure the audience can hear the message being sent.

Speed. The rate or rapidity in which words are spoken. Speaking too fast or too slow can be distracting to an audience. It is important to communicate at a pace that ensures the audience can understand every word being said.

Pause. A break in speaking or reading. A pause is an important part of the communication process. A pause gives the audience an opportunity to digest what has been said and to ask questions. A pause is also an effective way to announce a change in subject or an important point.

Articulation. The clear and distinct pronunciation of a word. It is important to properly pronounce and articulate words to ensure the audience can understand the message being sent.

CONFIRMATION OF TEACHING POINT 1

QUESTIONS

- Q1. Name the six elements of voice control.
- Q2. What can a change in volume signify when sending a message?
- Q3. What is the purpose of pausing while speaking?

ANTICIPATED ANSWERS

- A1. The six elements of voice control are:

- pitch,
- tone,
- volume,
- speed,
- pause, and
- articulation.

A2. A change in volume can signify emphasis on a particular phrase or point.

A3. A pause gives the audience an opportunity to digest what has been said and to ask questions. A pause is also an effective way to announce a change in subject or an important point.

Teaching Point 2

Discuss Elements of Physical Presence

Time: 10 min

Method: Group Discussion

BACKGROUND KNOWLEDGE



The purpose of the group discussion is to draw the following information from the group using the tips for answering/facilitating discussion and the suggested questions provided.

ELEMENTS OF PHYSICAL PRESENCE

It is estimated that 93 percent of the total meaning of a message comes from non-verbal communication and only 7 percent of meaning comes from the words themselves. Being aware of physical presence and its effect on a message being sent is an important element of effective communication.

Body Language

Body language or non-verbal communication is the process of communicating through conscious and unconscious gestures and expressions. Understanding that body language affects how a message is received and interpreted is an important tool for communicating effectively.

Facial Expressions. While 93 percent of the total meaning of a message comes from non-verbal communication, most of that meaning is communicated by the eyes, eyebrows and mouth. The movement of the eyes, eyebrows and mouth can result in an infinite variety of expressions to complement the spoken word. It is important that facial expressions match the tone of the message being sent to create emphasis and believability. A smile is the most important of all facial expressions. A smile adds sincerity to a message and will add to the likeability of the individual in front of the audience.

Eye Contact. Maintaining eye contact is an effective way of engaging an audience and building interest. Pausing two or three seconds on each member of the audience will make them feel as though they are involved in a one-on-one conversation. It is important to look at the entire room and scan from left to right, back to front.



Look for friendly, sympathetic faces to gain confidence and ease nervousness.

Gestures. The combination of hand, arm and shoulder movements can make a wide variety of gestures that can help add meaning to a message. Effective communicators will let their hands and arms move naturally to help give emphasis and emotion to a message. It is important not to point directly at members of the audience or let gestures become distracting.

Movement. Being aware of movement while in front of an audience is very important to communication. Movement will keep listeners engaged and interested in what is being said. Moving around the front of the room, toward and away from an audience and from side to side can help emphasize points. Too much or frantic movement can become distracting and will affect how a message is received.



Hands placed in pockets are typically a sign of nervousness or overconfidence.

Dress and Deportment.

Effective communicators are aware of their dress and deportment. Audiences will react differently to an individual who is well dressed and acts professionally, than an individual who is poorly dressed and acts unprofessionally.

Dress. Effective communicators will always appear in clean, well-pressed and appropriate attire. Dressing appropriately for the event will help create confidence and credibility.

Deportment. An audience that sees an individual as being prepared, on time, appropriately dressed and confident will be much more receptive, than to an individual who is unprepared, late, poorly dressed and nervous. The most important element of deportment is displaying an interest in the subject; this will be noticed by the audience and will generate interest in the presentation.

GROUP DISCUSSION



TIPS FOR ANSWERING/FACILITATING DISCUSSION

- Establish ground rules for discussion, eg, everyone should listen respectfully; don't interrupt; only one person speaks at a time; no one's ideas should be made fun of; you can disagree with ideas but not with the person; try to understand others as much as you hope they understand you; etc.
- Sit the group in a circle, making sure all cadets can be seen by everyone else.
- Ask questions that will provoke thought; in other words avoid questions with yes or no answers.
- Manage time by ensuring the cadets stay on topic.
- Listen and respond in a way that indicates you have heard and understood the cadet. This can be done by paraphrasing their ideas.
- Give the cadets time to respond to your questions.
- Ensure every cadet has an opportunity to participate. One option is to go around the group and have each cadet answer the question with a short answer. Cadets must also have the option to pass if they wish.
- Additional questions should be prepared ahead of time.

SUGGESTED QUESTIONS

- Q1. How could you use facial expressions to emphasize something that is funny?
- Q2. As an effective-speaker how could you make the audience feel like they are part of the presentation?
- Q3. How would you expect an instructor to present themselves in terms of dress and deportment?
- Q4. What is one of the most important elements of deportment?



Other questions and answers will develop throughout the group discussion. The group discussion should not be limited to only those suggested.



Reinforce the answers given and comments made during the group discussion, ensuring the teaching point has been covered.

CONFIRMATION OF TEACHING POINT 2

The cadets' participation in the group discussion will serve as the confirmation of this TP.

Teaching Point 3

Explain Effective-Speaking Preparation

Time: 5 min

Method: Interactive Lecture

Effective-speaking preparation is the most critical component of effective communication. Preparation will help to ensure confidence, control nervousness and increase the likelihood of success when in front of an audience.

The following are the steps to effective-speaking preparation:

1. **Practicing.** Proper rehearsal will aid in memorizing content, which will allow for more eye contact and movement while in front of an audience. Memorizing the introduction and conclusion are the two most critical elements; a strong introduction will aid in gaining confidence and will draw the interest of the audience, a strong conclusion will aid in leaving a lasting impression on the audience. If possible, practice in front of a small group, speak aloud even when practicing alone and always practice while standing.
2. **Controlling Nervousness.** The feeling of nervousness prior to speaking in front of a group is normal and often can help if channeled effectively. The following actions can be taken to control nervousness:
 - a. **Room Layout.** Become familiar with the layout of the room prior to speaking.
 - b. **Materials.** Ensure notes, handouts and presentation aids are organized.
 - c. **Equipment.** Ensure any equipment being used is in working order and ready to use.
 - d. **Practice.** Spend time going over notes and rehearsing content.
 - e. **Attitude.** Enter the room with a smile and a positive and confident attitude.

- f. **Breathing.** Take a deep breath before entering the room. Slow down the delivery if necessary and breathe from the diaphragm while speaking, not from the chest.
3. **Identifying a Friendly Face.** While walking in front of an audience, identify a friendly face. Making eye contact with a friendly face while beginning to speak will often give confidence while beginning the introduction and ultimately lead to success when addressing an audience.

CONFIRMATION OF TEACHING POINT 3

QUESTIONS

- Q1. What are the three steps to effective-speaking preparation?
- Q2. What actions can be taken to control nervousness?
- Q3. What is the benefit of identifying a friendly face?

ANTICIPATED ANSWERS

- A1. The three steps to effective-speaking preparation are:
1. practice,
 2. control nervousness, and
 3. identify a friendly face.
- A2. The actions that can be taken to control nervousness are:
- become familiar with the layout of the room prior to speaking,
 - ensure notes, handouts and presentation aids are well organized,
 - ensure any equipment being used is in working order and ready to use,
 - spend time going over notes and rehearse content,
 - enter the room with a smile and a positive and confident attitude, and
 - take a deep breath before entering the room.
- A3. Making eye contact with a friendly face while beginning to speak will often give confidence while beginning the introduction and ultimately lead to success when addressing an audience.

END OF LESSON CONFIRMATION

QUESTIONS

- Q1. What is meant by tone?
- Q2. What are the two elements of physical presence?
- Q3. What are the four aspects of body language?

ANTICIPATED ANSWERS

- A1. The quality of the sound of a voice.
- A2. The two elements of physical presence are:

- body language, and
- dress and deportment.

A3. The four aspects of body language are:

- facial expressions,
- eye contact,
- gestures, and
- movement.

CONCLUSION

HOMEWORK/READING/PRACTICE

N/A.

METHOD OF EVALUATION

N/A.

CLOSING STATEMENT

Knowing how to apply elements of voice control and physical presence will make instructing enjoyable and successful by helping develop presence while in front of an audience. The ability to effectively prepare for a presentation and control nervousness are invaluable skills that may help to develop a more confident instructor.

INSTRUCTOR NOTES/REMARKS

N/A.

REFERENCES

C1-133 (ISBN 0-9695066-2-7) Bender, P. (2000). *Secrets of Power Presentations*. Toronto, ON: The Achievement Group.

THIS PAGE INTENTIONALLY LEFT BLANK



COMMON TRAINING
PROFICIENCY LEVEL THREE
INSTRUCTIONAL GUIDE



SECTION 4

EO M309.04 – DESCRIBE QUESTIONING TECHNIQUES

Total Time:

30 min

PREPARATION

PRE-LESSON INSTRUCTIONS

Resources needed for the delivery of this lesson are listed in the lesson specification located in A-CR-CCP-803/PG-001, Chapter 4. Specific uses for said resources are identified throughout the instructional guide within the TP for which they are required.

Review the lesson content and become familiar with the material prior to delivering the lesson.

Arrange for officers or senior cadets to assist in conducting the activity and recording data regarding the cadets' performance.

Review the activity instructions with the officers and senior cadets assisting with the activity.

Photocopy Annexes E, F, G, and H for the officers and senior cadets assisting with the activity.

Photocopy Annex E for each cadet.

Assign spaces in the training area for workstations to conduct the activity if more than one group is used.

Make photocopies of Annex F for each station if necessary.

PRE-LESSON ASSIGNMENT

N/A.

APPROACH

An interactive lecture was chosen for TPs 1 to 3 as it allows the instructor to describe the purposes, qualities and types of questions while encouraging the cadets to actively participate by asking and responding to questions.

An in-class activity was chosen for TP 4 as it is an interactive way to reinforce the topic and confirm the cadets' comprehension of questioning techniques.

INTRODUCTION

REVIEW

N/A.

OBJECTIVES

By the end of this lesson the cadet shall have described questioning techniques by listing the purposes of questioning, listing the qualities of a good question, defining types of questions and by listing the steps to posing questions while instructing.

IMPORTANCE

Asking questions throughout a lesson helps the instructor to determine the cadets' level of comprehension of previously taught material, to create interest in the lesson and to confirm the cadets' comprehension of new material. Proper questioning techniques will help instructors ask questions properly to accomplish these goals and to develop confidence in their instructional abilities.

Teaching Point 1

Describe the Purposes of Questioning

Time: 5 min

Method: Interactive Lecture

PURPOSES OF QUESTIONING

Questions that are carefully developed and incorporated into a lesson plan may improve learning. In fact, instructors' use of questions has such an impact on learning that it can be considered an indicator of their overall effectiveness. Instructors may improve their questioning technique by carefully planning what questions to ask, when and how to ask them so as to improve their instructional ability.

Questions can be posed throughout a lesson to:

- determine the cadets' level of comprehension of previously taught related material;
- create and maintain interest by keeping the cadets mentally alert and making them feel more involved in the lesson;
- guide and provoke thinking by carefully selecting questions and following answers with other questions as the lesson progresses; and
- confirm learning, especially for knowledge lessons, by asking questions at the end of each TP and at the end of the lesson.

CONFIRMATION OF TEACHING POINT 1

QUESTIONS

- Q1. Why is questioning such an important aspect of instruction?
- Q2. How can instructors improve their questioning technique?
- Q3. What are four purposes of questioning?

ANTICIPATED ANSWERS

- A1. Questioning has a big impact on learning and is considered an indicator of an instructor's effectiveness.
- A2. By planning what questions to ask and when and how to ask them.
- A3. To determine comprehension of previously learned material, create and maintain interest, guide and provoke thinking, and to confirm learning.

Teaching Point 2**Describe the Qualities of a Good Question**

Time: 5 min

Method: Interactive Lecture

QUALITIES OF A GOOD QUESTION

Questions used during a lesson should be written out ahead of time. Instructors who consistently pay attention to writing good quality questions will improve their instruction and learn to instinctively phrase good questions when the situation demands it during a lesson.



Often the cadets who are being instructed ask questions for clarification. Effective instructors create a classroom atmosphere that encourages cadets to ask questions, which are relevant to the lesson.

The exact wording of a question is determined by its purpose and the situation in which it is asked. While the wording may vary, all questions should be:

- brief, complete and easily understood;
- stated clearly using simple language;
- a challenge to cadets to apply their knowledge;
- not so difficult that only a few cadets can answer; and
- relevant to the lesson by reinforcing and supporting the teaching points.

CONFIRMATION OF TEACHING POINT 2

QUESTIONS

- Q1. Why should questions be written out ahead of time?
- Q2. How can instructors learn to ask better quality questions while instructing?
- Q3. What are five qualities of good questions?

ANTICIPATED ANSWERS

- A1. Questions written out ahead of time are of better quality and will improve instruction.
- A2. By crafting good quality questions, the question-making process will become instinctive.
- A3. Brief and complete, clearly stated, challenging, not too difficult, and relevant.

Teaching Point 3**Describe Types of Questions**

Time: 5 min

Method: Interactive Lecture



All questions may be categorized as either participatory or evaluative. Participatory questions are used during a lesson to create and maintain interest, to keep cadets mentally alert and to guide thought. Evaluative questions are used at the beginning of a lesson to determine retention of previously taught material or at the end of a TP or lesson to confirm comprehension of new material.

There are many types of questions but those most commonly recognized include:

Lead-Off. Questions, which are used to begin a lecture or start a discussion. This type of question does not necessarily require a verbal or written response and is designed to get the cadets thinking about the topic of the lesson or the issue being discussed.

Example: "What does being a good cadet mean to you?"

Follow-Up. Questions that are used to further stimulate the cadets' thinking about the topic of the lesson or point of discussion. As the name suggests they are supplementary questions related to the initial lead-off question or are questions, which are phrased on the spot to probe an answer to a previous question or extend a point of discussion.

Example: "Identify an item, just mentioned in question one, that can be considered both a good and bad cadet quality."

Overhead. Questions that are asked to the whole group without indicating who is to reply. There will be several answers to this type of question and everyone should be given a chance to respond.

Example: "Identify one factor that can determine if a cadet quality is good or bad"

Direct. Questions that are the opposite of overhead questions because someone is directed to answer. These questions can be used to draw in those who are reluctant to take part in discussions, to prompt cadets who are inattentive or to get a discussion back on track.

Example: "Cadet I.M. Reluctant, can you think of another factor which determines if a cadet quality is good or bad?"

Reverse or Relay. Questions are used to keep the discussion in the hands of the cadets. Instead of answering a question posed by a cadet the instructor can reverse the question and return it to the person who asked it or relay it to another member of the class.

Example: "Cadet C. Legs, can you answer Cadet I.M. Reluctant's question?"



Never use reverse or relay as an escape mechanism for questions you cannot answer. Always admit that you don't know the answer and follow up later rather than use reverse and relay.

CONFIRMATION OF TEACHING POINT 3

QUESTIONS

Q1. Which type of question does not necessarily require a response?

Q2. Which type of question can be used to encourage cadets to take part in a discussion?

Q3. What is one thing to avoid when using reverse and relay questions?

ANTICIPATED ANSWERS

A1. Lead-off.

A2. Direct.

A3. Trying to hide the fact that an instructor doesn't know the answer to a question.

Teaching Point 4

Conduct an Activity Where the Cadets Will Practice Posing Questions Using the Pose, Pause, Pounce, Ponder and Praise Sequence

Time: 10 min

Method: In-Class Activity

ACTIVITY

OBJECTIVE

The objective of this activity is to introduce cadets to a posing questions sequence that they can follow when asking questions while instructing, particularly during M309.07 (Instruct a 15-Minute Lesson, Section 7).

RESOURCES

- Posing questions sequence handout located at Annex E,
- Questions handout located at Annex F,
- Posing questions rubric located at Annex G, and
- Posing questions checklist located at Annex H.

ACTIVITY LAYOUT

Set up work stations, if necessary, labelled A, B, C, etc. and place the following at each station:

- a copy of the posing questions sequence handout,
- a copy of the questions, and
- pens/pencils.



If possible brief the assisting staff and the cadets prior to the lesson.



The activity can be used with one group of five to ten cadets or several smaller groups if numbers warrant. The objective is to have each cadet follow the question posing sequence for at least one question but they can ask more than one if necessary. If the group is larger than five other questions can be devised using the children's story, "Goldilocks and the Three Bears."

ACTIVITY INSTRUCTIONS

Divide cadets into groups, if necessary, and assign a supervisor and letter name to each group.

1. Brief the assisting staff that they will be expected to:
 - a. assign each cadet in their group a number from one to five indicating the order in which they will take part in the activity;
 - b. move their groups to the appropriately named area to conduct the activity;
 - c. read the introduction to the children's story, "Goldilocks and the Three Bears" to the cadets;
 - d. ask Cadet # 1 to pose the first question from Annex F and record information on the checklist describing their performance;
 - e. carry out the same procedure for each succeeding cadet;
 - f. provide feedback to each cadet regarding their performance;
 - g. return the group to the main area; and
 - h. give the completed posing questions checklist to the instructor.
2. Ensure that assisting staff have a copy of Annexes E, F, G and H.
3. Brief the cadets that they will:
 - a. listen to a short introduction to the children's story, "Goldilocks and the Three Bears";
 - b. use a question posing sequence to ask one question to their group based on the children's story, "Goldilocks and the Three Bears"; and
 - c. be supervised and corrected on the spot if they do not follow the posing questions sequence properly.
4. Have the cadets begin the activity.
5. Circulate throughout the training area observing the groups as they take part in the activity.
6. Debrief the cadets on their performance.



Remind cadets that the activity was designed to introduce a posing questions sequence that they can follow when asking questions while instructing, particularly during M309.07 (Instruct a 15-Minute Lesson, Section 7).

SAFETY

N/A.

CONFIRMATION OF TEACHING POINT 4

The cadets' participation in the activity will serve as the confirmation of this TP.

END OF LESSON CONFIRMATION

QUESTIONS

- Q1. What are the four purposes for asking questions?
- Q2. List two qualities of a good question.
- Q3. List two types of questions most commonly recognized.
- Q4. List the five parts of the question posing sequence.

ANTICIPATED ANSWERS

- A1. The four purposes of questions are:
- to determine the cadets' level of comprehension of previously taught material;
 - to create and maintain interest;
 - to guide and provoke thinking; and
 - to confirm learning of new material.
- A2. Good questions should be brief and complete, written clearly using simple language, challenging, not too difficult and relevant to the lesson.
- A3. The types of questions most commonly recognized are lead-off questions, follow-up questions, overhead questions, direct questions and reverse or relay questions.
- A4. The five parts of the question posing sequence are pose, pause, point, ponder and praise.
-

CONCLUSION

HOMEWORK/READING/PRACTICE

N/A.

METHOD OF EVALUATION

N/A.

CLOSING STATEMENT

The question is an important tool for the instructor. It is useful for instructors to know the purposes, qualities and types of questions but should keep in mind that this knowledge alone will not necessarily improve questioning technique. Carefully writing out questions before hand and asking them properly are just as important when using questions while instructing a lesson.

INSTRUCTOR NOTES/REMARKS

N/A.

REFERENCES

- A1-041 A-P9-050-000/PT-006 Director Training and Education Policy. (2002). *Canadian Forces Individual Training and Education System* (Vol. 6). Ottawa, ON: Department of National Defence.
- A1-042 A-P9-050-000/PT-005 Director Training and Education Policy. (2001). *Canadian Forces Individual Training and Education System* (Vol. 5). Ottawa, ON: Department of National Defence.
- A1-048 A-CR-CCP-913/PT-001 Cadet Instructors List Training School. (1978). *Technique of Instruction*. Ottawa, ON: Department of National Defence.



COMMON TRAINING
PROFICIENCY LEVEL THREE
INSTRUCTIONAL GUIDE



SECTION 5

EO M309.05 – SELECT APPROPRIATE INSTRUCTIONAL AIDS

Total Time:

60 min

PREPARATION

PRE-LESSON INSTRUCTIONS

Resources needed for the delivery of this lesson are listed in the lesson specification located in A-CR-CCP-803/PG-001, Chapter 4. Specific uses for said resources are identified throughout the instructional guide within the TP for which they are required.

Review the lesson content and become familiar with the material prior to delivering the lesson.

The activity in TP 2 uses learning stations. Learning stations are a form of group work where the cadets learn by sorting through the information presented. When setting up learning stations, ensure there is enough room for each cadet to be comfortable and have adequate space for writing down information. When the cadets arrive at a learning station, all required information shall be available. These stations should be placed close together to minimize time for movement; however far enough apart to avoid interruptions from other groups. For this lesson, choose and set up five learning stations.

Photocopy the handouts located at Annexes I and J and place a copy of each at the appropriate learning station.

Samples of instructional aids available at the squadron should be used during this lesson.

PRE-LESSON ASSIGNMENT

N/A.

APPROACH

An interactive lecture was chosen for TP 1 to introduce instructional aids, as it allows the instructor to deliver new information while encouraging the cadets to actively participate by asking and responding to questions.

An in-class activity was chosen for TP 2 as it is an interactive way to introduce the cadets to the different types of instructional aids and to confirm the cadets' comprehension of the material presented.

INTRODUCTION

REVIEW

N/A.

OBJECTIVES

By the end of this lesson the cadet shall have identified and selected appropriate instructional aids for a given topic.

IMPORTANCE

It is important for cadets to know that selecting appropriate instructional aids is an important part of pre-lesson preparation. Using instructional aids during a lesson helps stimulate the cadets' interest and helps them comprehend and recall the new material.

Teaching Point 1

Describe Instructional Aids

Time: 5 min

Method: Interactive Lecture

INSTRUCTIONAL AIDS

Instructional aids consist of various types of learning support that emphasize and clarify teaching points. Instructional aids include handouts, verbal support, audiovisual aids, simulators and real equipment. Instructional aids can be produced locally or purchased externally but must:

- be relevant to the teaching point;
- support learning; and
- be appropriate to the cadets' background and needs.

Instructional aids can be categorized as:

- **Training Aids.** Training aids refer to all types of learning support instructors use to instruct the lesson.
- **Learning Aids.** Learning aids refer to all the materials the cadets use to participate in the lesson and comprehend the material.

CONFIRMATION OF TEACHING POINT 1

QUESTIONS

- Q1. How can instructional aids support learning?
- Q2. How can instructional aids be obtained?
- Q3. What is the difference between a training aid and a learning aid?

ANTICIPATED ANSWERS

- A1. Instructional aids support learning by emphasizing and clarifying teaching points.
- A2. Instructional aids can be produced locally or purchased externally.
- A3. A training aid is used by the instructor to instruct the lesson and a learning aid is used by the cadet to participate in the lesson and comprehend the material.

Teaching Point 2**Conduct an Activity Where the Cadets Will Identify Types of Instructional Aids and Select an Instructional Aid Appropriate for a Given Topic**

Time: 45 min

Method: In-Class Activity

BACKGROUND KNOWLEDGE

The saying “a picture is worth a thousand words”, describes the effectiveness of instructional aids. New instructional aids are being developed all the time and it is important for instructors to know what aids are available, when to use them and how to use them. Some of the more common instructional aids are described in Annex I.



“Show 'em as well as tell 'em!” Cadets will remember more for longer periods of time.

ACTIVITY**OBJECTIVE**

The objective of this activity is to have cadets identify types of instructional aids and select an instructional aid appropriate for a given topic.

RESOURCES

- Instructional aids information sheets,
- Worksheets,
- Stopwatch,
- Signalling device,
- Flip chart paper,
- Coloured markers, and
- Pens/pencils.

ACTIVITY LAYOUT

Set up and label five learning stations “Instructional Aids”, “Verbal Support”, “Audiovisual Aids”, “Simulators and Training Equipment” and “Select an Instructional Aid.”

ACTIVITY INSTRUCTIONS

1. Divide the cadets into five groups and place one group at each learning station.
2. Assign each group a leader. Have the group leader assign a recorder and a reader.
3. Have the cadets read the information sheets and fill out a worksheet on each aspect of instructional aids. It is necessary for each group to fill out only one worksheet.

4. After eight minutes, have the groups rotate clockwise to the next station, where they will have another eight minutes to complete a worksheet.
5. Rotate the groups through the remaining stations.
6. Have the cadets share the information they recorded from each station.

SAFETY

N/A.

CONFIRMATION OF TEACHING POINT 2

The cadets' participation in the activity will serve as the confirmation of this TP.

END OF LESSON CONFIRMATION

The cadets' participation in the instructional aids activity in TP 2 will serve as the confirmation of this lesson.

CONCLUSION

HOMEWORK/READING/PRACTICE

N/A.

METHOD OF EVALUATION

This EO is assessed IAW A-CR-CCP-803/PG-001, Chapter 3, Annex B, Appendix 3 (309 PC).

CLOSING STATEMENT

Instructional aids appeal to all five senses but mainly to our senses of sight and hearing. It has often been reported that 75 percent of all learning happens through sight and that you remember 50 percent more when you both see and hear the information. It naturally follows therefore, that learning is enhanced when instructional aids are used.

INSTRUCTOR NOTES/REMARKS

Samples of instructional aids available at the squadron should be used during this lesson.

REFERENCES

- | | |
|--------|---|
| A1-041 | A-P9-050-000/PT-006 Director Training and Education Policy. (2002). <i>Canadian Forces Individual Training and Education System</i> . (Vol. 6). Ottawa, ON: Department of National Defence. |
| A1-042 | A-P9-050-000/PT-005 Director Training and Education Policy. (2001). <i>Canadian Forces Individual Training and Education System</i> . (Vol. 5). Ottawa, ON: Department of National Defence. |
| A1-043 | A-P9-050-000/PT-004 Director Training and Education Policy. (1999). <i>Canadian Forces Individual Training and Education System</i> . (Vol. 4). Ottawa, ON: Department of National Defence. |
| A1-048 | A-CR-CCP-913/PT-001 Cadet Instructors List Training School. (1978). <i>Technique of Instruction</i> . Ottawa, ON: Department of National Defence. |

C1-141 Dynamic Flight, Inc. *Instructional Aids and Training Technologies*. (2003). Retrieved March 20, 2008, from http://www.dynamicflight.com/avcfibook/inst_aids/.

THIS PAGE INTENTIONALLY LEFT BLANK



COMMON TRAINING
PROFICIENCY LEVEL THREE
INSTRUCTIONAL GUIDE



SECTION 6

EO M309.06 – PLAN A LESSON

Total Time:

60 min

PREPARATION

PRE-LESSON INSTRUCTIONS

Resources needed for the delivery of this lesson are listed in the lesson specification located in A-CR-CCP-803/PG-001, Chapter 4. Specific uses for said resources are identified throughout the instructional guide within the TP for which they are required.

Review the lesson content and become familiar with the material prior to delivering the lesson.

Photocopy the lesson specification and instructional guide handout located at Annex K, the blank lesson plan located at Annex L and the plan a lesson checklist located at Annex M for each cadet.

Photocopy the lesson specifications and instructional guides located at Annexes O to AC as required.

PRE-LESSON ASSIGNMENT

N/A.

APPROACH

An interactive lecture was chosen for TPs 1 to 3 to present basic material on how to research lesson content and how to prepare for a lesson.

A practical activity was chosen for TP 4 to allow the cadets to plan a lesson in a structured and controlled environment. This activity contributes to the development of lesson-planning skills and will serve as preparation for EO M309.07 (Instruct a 15-Minute Lesson, Section 7).

INTRODUCTION

REVIEW

N/A.

OBJECTIVES

By the end of this lesson the cadet shall be expected to research lesson content and develop a lesson plan.

IMPORTANCE

It is important for cadets to research lesson content, prepare a lesson location and plan a lesson because these are critical steps to the success of a period of instruction. The preparation of a lesson location sets the tone for

the lesson and a well-developed lesson plan provides structure and organization, guides the instructor through each stage of the lesson and ensures that all essential information is delivered.

Teaching Point 1

Explain How to Research Lesson Content

Time: 10 min

Method: Interactive Lecture



Some common abbreviations and terms used by training officers and instructors:

- **QSP.** Qualification Standard and Plan.
- **PO.** Performance Objective.
- **EO.** Enabling Objective.
- **TP.** Teaching Point.
- **PC.** Performance Check.
- **EC.** Enabling Check.
- **IG.** Instructional Guide.

RESEARCHING LESSON CONTENT

To plan for a lesson, the cadets will need to research lesson content and become familiar with the conditions, standard, TPs, lesson content and the time allocated for the EO and TPs.

The Canadian Forces employs an acronym that is used to provide a framework for the instructor to gather and organize the reference material into an efficient and practical lesson plan. The initialism is CCSAM.

Collect. During this step, the instructor researches the material to be covered in the period of instruction using course documents such as the lesson specification, IG and listed references. In situations where no course documents exist, the instructor will research the material to be taught using whatever references exist.

Consider. During this step, the instructor sifts through all of the material found in the collection step and determines what is relevant and current.

Select. During this step, instructor selects the material that is appropriate for the lesson. The instructor also selects the method of instruction to be used.

Arrange. During this step, the instructor arranges the material into stages that allow for the information to be presented in a logical sequence.

Master. During this step, the instructor writes the lesson plan.



The use of CCSAM is a good general practice. In most cases for cadet training these steps have been completed during the development of the lesson specifications and IGs. The instructor may need to only transpose the information into the pertinent parts of their lesson plan.



Distribute the lesson specification and instructional guide handout located at Annex K to each cadet.

ENABLING OBJECTIVE AND LESSON SPECIFICATION



Enabling objectives and lesson specifications can be found in Chapter 4.

Performance objectives are broken down into a series of enabling objectives and lesson specifications. The enabling objective consists of Paragraphs 1. to 3. (as illustrated in Figure 9-6-1). The information in these paragraphs will answer three questions:

1. What will the cadet be expected to be able to do by the end of this lesson?
2. Under what conditions will the cadet be expected to carry out the performance?
3. How well or to what standard will the cadet be expected to perform?

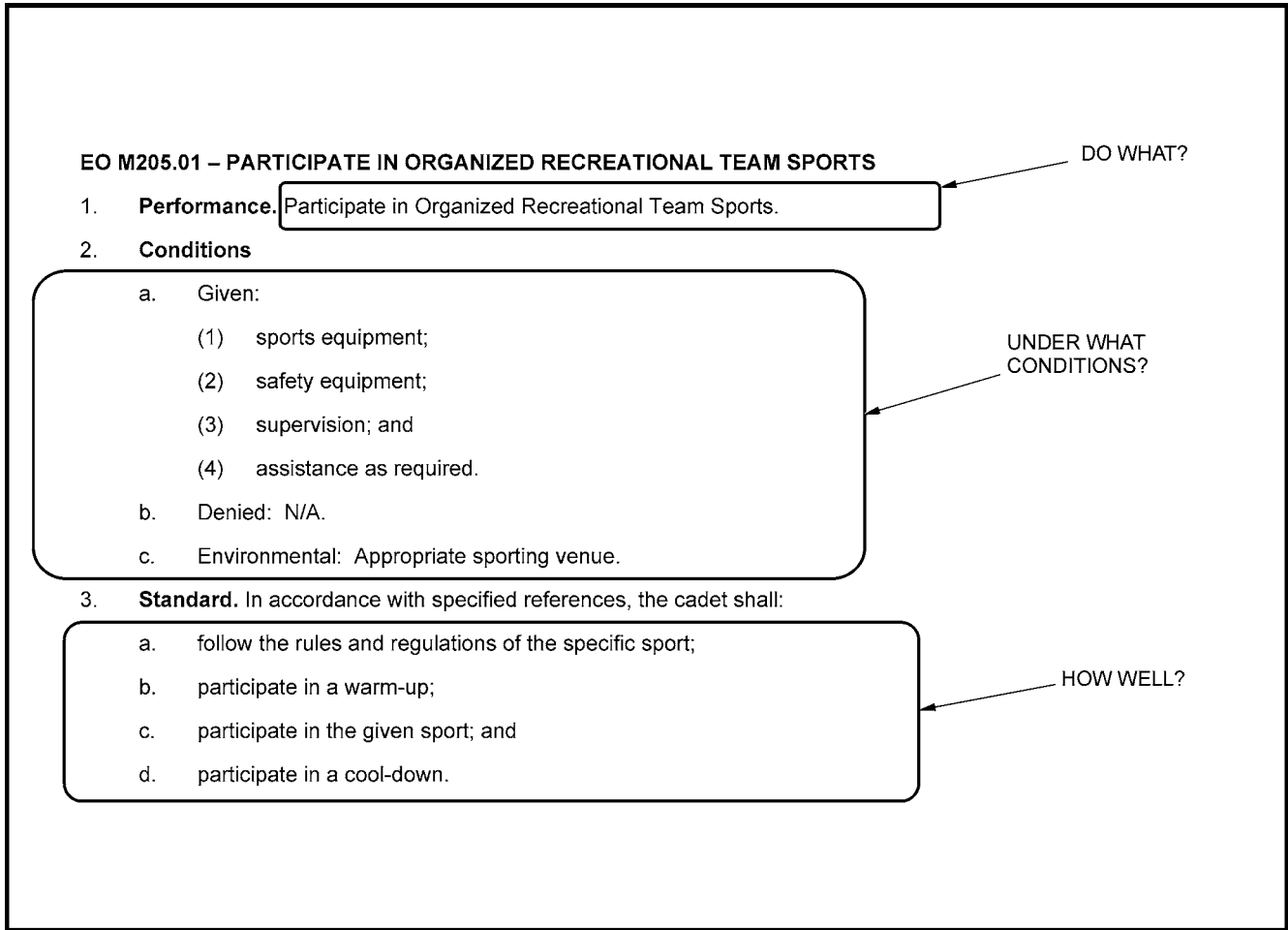

Director Cadets 3, 2008, Ottawa, ON: Department of National Defence

Figure 9-6-1 Enabling Objective

Paragraphs 4 to 11 are known as the lesson specification. The lesson specification provides information about the content to be taught, teaching methods, time, references, training aids, learning aids, test details and remarks.

In Paragraph 4., the TPs are usually described in a table where information is provided on the content taught in each TP, the suggested teaching method, the time for each TP and references (as illustrated in Figure 9-6-2).

4. Teaching Points

TP	Description	Method	Time	Ref
TP1	Introduce cadets to a specific sport's rules and regulations, to include: <ul style="list-style-type: none"> a. an overview of how to play the sport; and b. rules and regulations of the sport. 	Interactive Lecture	10 min	C0-001
TP2	Conduct a warm-up session, composed of light cardiovascular exercises, meant to: <ul style="list-style-type: none"> a. stretch the muscles; b. gradually increase respiratory action and heart rate; c. expand the muscles' capillaries to accommodate the increase in blood circulation; and d. raise muscle temperature to facilitate reactions in muscle tissue. 	Practical Activity	10 min	C0-002 (pp. 109 to 113) C0-089
TP3	Supervise the cadets' participation in a given sports activity.	Practical Activity	50 min	

CONTENT TO BE TAUGHT

LENGTH OF TP

REFERENCE NUMBER

SUGGESTED TEACHING METHOD

Director Cadets 3, 2008, Ottawa, ON: Department of National Defence

Figure 9-6-2 Teaching Points

Paragraph 5. outlines how much time is spent on the introduction/conclusion and the different teaching methods. Paragraph 6. offers substantiation or reasons why certain teaching methods were recommended for each TP. Paragraph 7. provides a list of references used to compile the content in Paragraph 4. (as illustrated in Figure 9-6-3).

- | | |
|-----------------------------|---|
| 5. Time | |
| a. Introduction/Conclusion: | 10 min |
| b. Interactive Lecture: | 10 min |
| c. Practical Activity: | 70 min |
| d. Subtotal: | 90 min |
| e. Total (three sessions): | 270 min |
| 6. Substantiation | |
| a. | An interactive lecture was chosen for TP1 to illustrate the application of rules, principles, or concepts of the specific sport to be played. |
| b. | A practical activity was chosen for TP2–4 as it allows cadets to participate in sports activities in a safe and controlled environment. This activity contributes to the development of sports skills in a fun and challenging setting. |
| 7. References | |
| a. | C0-001 (ISBN 0-88011-807-5) Hanlon, T. (1998). <i>The Sports Rules Book: Essential Rules for 54 Sports</i> . USA: Human Kinetics Publishers, Inc. |
| b. | C0-002 (ISBN 0-88962-630-8) LeBlanc, J., and Dickson, L. (1997). <i>Straight Talk About Children and Sport: Advice for Parents, Coaches, And teachers</i> . Oakville, ON and Buffalo, NY: Mosaic Press. |

Director Cadets 3, 2008, Ottawa, ON: Department of National Defence

Figure 9-6-3 Paragraphs 5–7

Paragraphs 8. and 9. list the training aids and learning aids required for the lesson. Training aids are the materials that are required by the instructor to instruct the lesson and learning aids are the materials that will be required by the cadet to participate in the lesson (as illustrated in Figure 9-6-4).

- | | |
|--|---|
| 8. Training Aids | |
| a. | Sports/safety equipment appropriate for the activity; |
| b. | First aid kit; |
| c. | Whistles; and |
| d. | Stopwatch. |
| 9. Learning Aids. Sports equipment. | |

Director Cadets 3, 2008, Ottawa, ON: Department of National Defence

Figure 9-6-4 Training Aids and Learning Aids

Paragraph 10. is test details, which is information about the evaluation to be conducted. Paragraph 11. is remarks, which describe any other information that may be useful to the Training Officer or instructor (as illustrated in Figure 9-6-5).

- | |
|--|
| <p>10. Test Details. N/A.</p> <p>11. Remarks</p> <p>a. The CCO list of approved sports is located at A-CR-CCP-802/PF-001, Annex A.</p> <p>b. Recreational sports can be carried out as nine periods during a supported day or over three sessions of three periods each.</p> |
|--|

Director Cadets 3, 2008, Ottawa, ON: Department of National Defence

Figure 9-6-5 Test Details and Remarks



Test details will be described in one of the following ways:

- **N/A.** No evaluation for this EO.
- **This EO is assessed IAW Chapter 3, Annex B, Appendix 3 (209 PC).** There is a performance check (PC) associated with this EO, refer to Chapter 3, Annex B for details.
- **This EO is assessed IAW Chapter 3, Annex B, Appendix 3 (209 EC 01).** There is an enabling check (EC) associated with this EO, refer to Chapter 3, Annex B for details.

INSTRUCTIONAL GUIDE

The IG is used in conjunction with the QSP and other resources to conduct training. IGs should be reviewed in conjunction with lesson specifications so that the instructor can adequately plan and prepare their lesson. IGs do not replace lesson plans but offer written content, supporting figures and suggestions on how to instruct a lesson. The following are the six sections of an IG:

1. preparation,
2. introduction,
3. body,
4. conclusion,
5. references, and
6. annexes.

Preparation

The preparation section provides information about where to find the lesson specification and any instructions to the instructor such as reviewing lesson content, photocopying handouts, pre-lesson assignments and the approach and substantiation as to why certain teaching methods were recommended for each TP.





Introduction

The introduction section provides information to the instructor about review that may be necessary, what the cadet will be expected to do by the end of the lesson and why the knowledge/skills are important.

The Body

The body of the IG contains all of the TPs and content listed in Paragraph 4. of the lesson specification in greater detail. The body provides suggested teaching methods, note boxes with special instructions or information (as illustrated in Figure 9-6-6), lesson content, figures, activities and confirmation questions.

Note Boxes:

	Special note to the instructor.
	Key information to pass along the cadets.
	Refer to the following CF regulations and policies.
	Points of interest or special instructions the instructor should pass along to the cadets.

Director Cadets 3, 2008, Ottawa, ON: Department of National Defence

Figure 9-6-6 Note Boxes

The Conclusion

The conclusion section states any homework/reading/practice that may be required of the cadet and the method of evaluation as stated in the lesson specification. The conclusion section also provides a closing statement to be spoken aloud to the cadets and any additional instructor notes/remarks.

References

The reference section lists the references used to create the lesson specification and instructional guide. In some cases, an IG may direct the instructor to a specific reference to be used during a lesson. In most cases this section is only used to identify where the content of the lesson has been drawn from.

Annexes

The annex section contains information that may range from pre-made training aids, learning aids such as handouts and additional information for activities.

CONFIRMATION OF TEACHING POINT 1

QUESTIONS

- Q1. Where can a lesson specification be found?
- Q2. What information can be found in the preparation section of an instructional guide?
- Q3. What information can be found in the body of an instructional guide?

ANTICIPATED ANSWERS

- A1. In Chapter 4 of the QSP.
- A2. The preparation section provides information about where to find the lesson specification and any instructions to the instructor such as reviewing lesson content, photocopying handouts, pre-lesson assignments and the approach and substantiation as to why certain teaching methods were recommended for each TP.
- A3. The body of the IG contains all of the TPs and content listed in Paragraph 4. of the lesson specification in greater detail. The body provides suggested teaching methods, note boxes with special instructions or information (as illustrated in Figure 9-6-6), lesson content, figures, activities and confirmation questions.

Teaching Point 2

Explain How to Prepare for a Lesson

Time: 5 min

Method: Interactive Lecture

PREPARING FOR A LESSON

A well-prepared and positive learning environment can enhance a lesson and the learning experience. The cadets' attention will not only be focused on the instructor but also on the environment around them. Effort put into lesson preparation and presentation can be wasted if the environment is not prepared for optimal learning.

Selecting a Lesson Location

When selecting a lesson location the instructor should consider the following:

- the type of training to be conducted (eg, leadership versus aviation subjects);
- any activities outlined in the instructional guide;
- the size of the group being trained;
- the size of the location;
- the lighting of the location;
- the ventilation of the location;
- the suitability of the location regarding noise distractions; and
- the suitability of the location regarding the use of visual aids.

Setting Up the Location

After selecting a lesson location, the instructor must take steps to ensure the location is clean and arranged properly for an optimal training environment.

Cleanliness. A clean training area will prevent distractions and will positively affect motivation. Cadets will notice a messy, disorganized area immediately and will be distracted before the class begins. The room must be clean and well-organized with the boards wiped clean, debris picked up, garbage cans empty, etc.

Seating Arrangements. Cadets must be able to see the instructor, the visual aids and each other to achieve maximum participation. Some arrangements will not be possible given the allotted space. The following descriptions and diagrams depict possible seating arrangements:

- **U-Shaped.** Allows the instructor to see all cadets easily and also allows trainees to see each other.

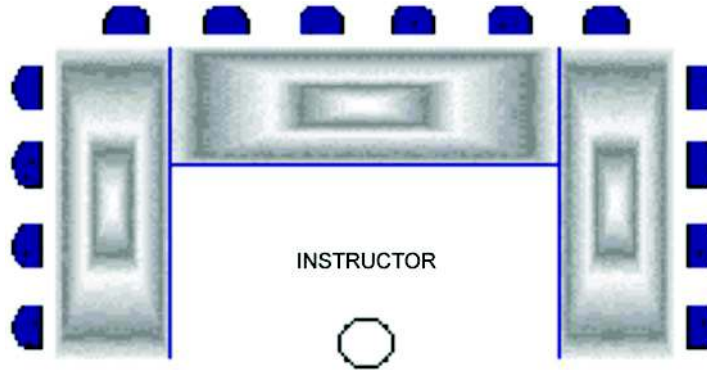

E. Jenson, Super Teaching: Mastering Strategies for Building Trainee Success, The Brain Store Inc. (p. 109)

Figure 9-6-7 U-Shaped

- **Chevron Shape.** Found mostly in auditorium-style rooms and can accommodate large groups.

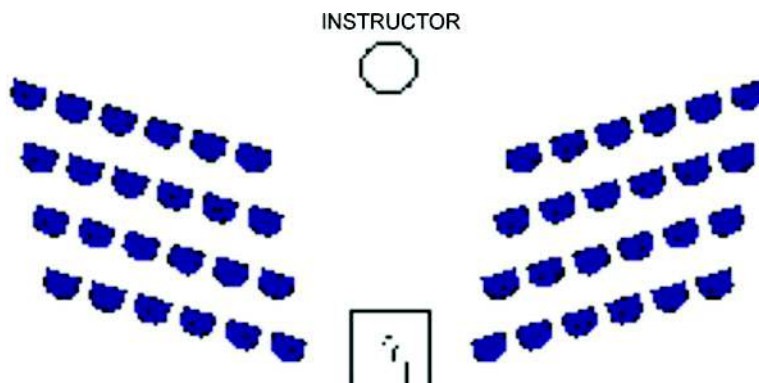

E. Jenson, Super Teaching: Mastering Strategies for Building Trainee Success, The Brain Store Inc. (p. 109)

Figure 9-6-8 Chevron Shape

- **Horseshoe.** Can be employed for two groups. This set-up works well during debates and in-class activities.

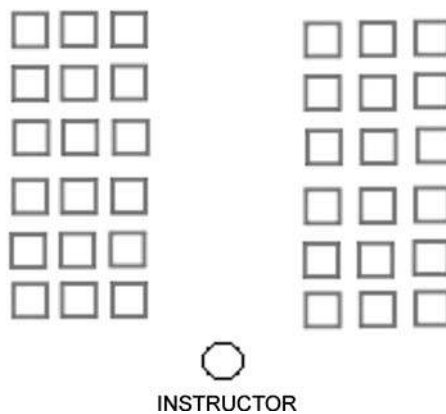

E. Jenson, Super Teaching: Mastering Strategies for Building Trainee Success, The Brain Store Inc. (p. 109)

Figure 9-6-9 Horseshoe

- **Semicircle.** Instructor has a good view of the cadets.

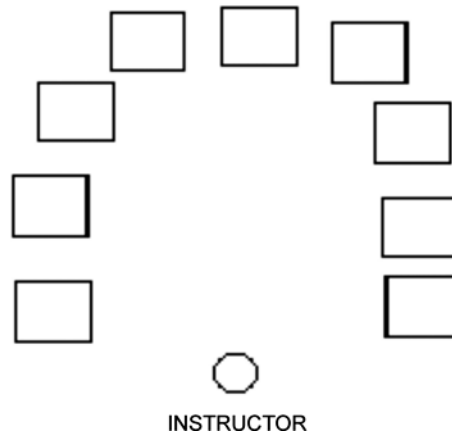

E. Jensen, Super Teaching: Mastering Strategies for Building Trainee Success, The Brain Store Inc. (p. 109)

Figure 9-6-10 Semicircle

- **Standard in Line.** Allows for more frontal coverage with less depth front to back.

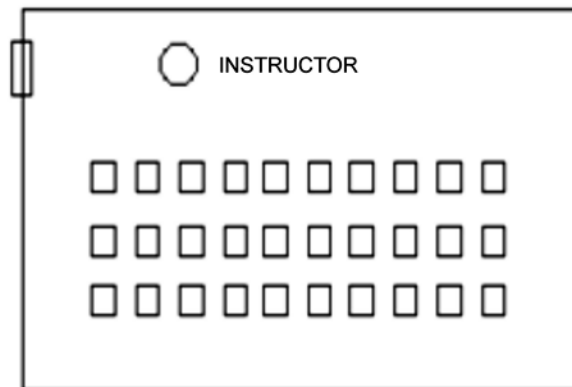

E. Jensen, Super Teaching: Mastering Strategies for Building Trainee Success, The Brain Store Inc. (p. 109)

Figure 9-6-11 Standard in Line

CONFIRMATION OF TEACHING POINT 2

QUESTIONS

- Q1. What should the instructor consider when selecting a lesson location?
- Q2. Why is it important to have a clean lesson location?
- Q3. What are three seating arrangements?

ANTICIPATED ANSWERS

- A1. When selecting a lesson location the instructor should consider the following:
- the type of training to be conducted (eg, leadership versus aviation subjects);
 - any activities outlined in the instructional guide;
 - the size of the group being trained;

- the size of the location;
- the lighting of the location;
- the ventilation of the location;
- the suitability of the location regarding noise distractions; and
- the suitability of the location regarding the use of visual aids.

A2. Cadets will notice a messy, disorganized area immediately and will be distracted before the class begins.

A3. Seating arrangements are:

- u-shaped,
- chevron shape,
- horseshoe,
- semicircle, and
- standard in line.

Teaching Point 3

Describe the Lesson Plan Format

Time: 10 min

Method: Interactive Lecture

LESSON PLAN FORMAT

The lesson plan is a way for the instructor to organize the lesson and summarize the information included in the lesson specification, the IG and their personal ideas. Lesson plans provide a set of detailed directions for delivering one or more periods of instruction.

The lesson plan is arranged in this specific order:

Part		Purpose
1.	Introduction	Builds the cadets' interest and motivation.
2.	Body	Presents and explains each TP.
3.	End of Lesson Confirmation	Confirms cadets' comprehension of the lesson.
4.	Conclusion	Summarizes key points and identifies future lessons.

Introduction

The introduction is the instructor's first verbal interaction with the cadets. It should capture the cadets' interest. The following should be included in the introduction of a lesson plan:

- **What.** A description of what the cadets will be expected to accomplish at the end of the lesson.
- **Where.** A description of how and where the lesson fits into the Cadet Program.
- **Why.** A description of why it is important for the cadets to achieve the objectives.



Read the Objective and Importance paragraphs in the IG for help in writing the introduction of the lesson plan.

Body

The body of the lesson plan is where the content is presented, explained and supported. Each TP directs the instructor and the cadets.

Each TP in the lesson includes:

- **Introduction.** Briefly introduce the content to be taught during the TP.
- **Teaching Method.** Identify which teaching method has been chosen for the TP.
- **Lesson Content.** Present the content of the TP in a clear and logical order, from easy to difficult, known to unknown and simple to complex.
- **Confirmation.** May be oral questions, games, role play, in-class activities or practical activities. IGs offer suggestions for how to confirm TPs. Instructors may choose to use those confirmation suggestions or develop their own.

End of Lesson Confirmation

The lesson plan should outline procedures to be used to confirm the learning of the TP. End of lesson confirmations are carried out to ensure that the cadets have understood the whole lesson and that any weaknesses in performance are identified so they can be corrected.

Confirmation activities are based on the lesson objectives. The end of lesson confirmation may be oral questions, games, role play, in-class activities or practical activities. IGs offer suggestions for how to conduct end of lesson confirmations. Instructors may choose to use those confirmation suggestions or develop their own.

Conclusion

The conclusion of a lesson summarizes the key points and links them to the coming lessons and their practical use.

A Summary of Important Points and Weak Areas. The summary reviews the main TPs. The depth of the summary will be determined by the lesson objectives and the results of the cadets' end of lesson confirmation. If the cadets achieved the objectives successfully, the summary may be brief. If they experienced some difficulties, the instructor should identify them here and indicate how the issue will be addressed.

Re-Motivation Statement. The re-motivation statement restates the importance of the lesson (the "why") and re-motivates the cadets. The instructor should also take this time to address any precautions the cadets should be aware of when applying the knowledge in a practical setting and give an overview of the next lesson.



Read the Closing Statement paragraph in the IG for help in writing the conclusion of the lesson plan.

CONFIRMATION OF TEACHING POINT 3

QUESTIONS

Q1. What are the four sections of a lesson plan?

Q2. What three questions are answered in the introduction?

Q3. What are the four sections of a teaching point?

ANTICIPATED ANSWERS

A1. The four sections of a lesson plan are:

- introduction,
- body,
- end of lesson confirmation, and
- conclusion.

A2. The three questions answered in the introduction are:

- what,
- where, and
- why.

A3. The four sections of a teaching point are:

- introduction,
- teaching method,
- lesson content, and
- confirmation.

Teaching Point 4

Supervise and Provide Assistance While the Cadets Plan a Lesson

Time: 25 min

Method: Practical Activity

In EO M309.07 (Instruct a 15-Minute Lesson, Section 7) the cadets will be expected to instruct a lesson using a lesson plan, an instructional aid and the appropriate instructional method. The lesson plan created in this EO will be used to instruct that lesson.



Distribute the blank lesson plan located at Annex L and the plan a lesson checklist located at Annex M to each cadet.



As the cadets begin to place information in the lesson plan, they will need to know what information to place in the two columns not discussed in the previous TP.

Time. This column reminds the instructor how long to spend on each section of the lesson.

Notes. The instructor can place information in this column as a reminder of when to distribute a handout, to pass along special information to the class or information about a confirmation activity.

LESSON PLAN		
INSTRUCTIONS AND REMINDERS		
EO #:	Title of the EO:	
Instructor:	Location:	Total Time: min
TIME	INTRODUCTION	NOTES
3 min	What: Where: Why:	Distribute handouts here.
TIME	BODY	NOTES
10 min	TP Teaching Method: TP 1:	Use analogy here

EXPECTED TIME

Director Cadets 3, 2008, Ottawa, ON: Department of National Defence

Figure 9-6-12 Lesson Plan

ACTIVITY

OBJECTIVE

The objective of this activity is to have the cadets plan a 15-minute lesson.

RESOURCES

- List of approved 15-minute topics located at Annex N, and
- Modified lesson specifications and instructional guides located at Annexes O to AC.

ACTIVITY LAYOUT

N/A.

ACTIVITY INSTRUCTIONS

1. Have each cadet choose a topic from the list of approved 15-minute topics.
2. Have the cadets use the lesson specification and IG for their chosen topic to help develop their lesson plan. Cadets shall be expected to teach their chosen lesson as part of M309.07 (Instruct a 15-Minute Lesson, Section 7).
3. Circulate around the room facilitating the activity and helping the cadets as required.

	Ensure that cadets request all resources required to instruct their lesson.
---	---

SAFETY

N/A.

CONFIRMATION OF TEACHING POINT 4

The cadets' participation in the activity will serve as the confirmation of this TP.

END OF LESSON CONFIRMATION

The cadets' completion of a lesson plan will serve as the confirmation of this lesson.

CONCLUSION

HOMEWORK/READING/PRACTICE

The cadets should be prepared to instruct their lesson at the beginning of M309.07 (Instruct a 15-Minute Lesson, Section 7).

METHOD OF EVALUATION

This EO is assessed IAW A-CR-CCP-803/PG-001, Chapter 3, Annex B, Appendix 3 (309 PC).

CLOSING STATEMENT

Researching lesson content, preparing a lesson location and planning a lesson are critical steps in preparing a period of instruction. The preparation of a lesson location sets the tone for the lesson to be taught and a well-developed lesson plan provides structure and organization, guides the instructor through each stage of the lesson and ensures that all essential information is delivered.

INSTRUCTOR NOTES/REMARKS

EO M309.06 (Plan a Lesson) should be scheduled at least one week prior to EO M309.07 (Instruct a 15-Minute Lesson, Section 7).

EO C309.02 (Plan a Lesson, A-CR-CCP-803/PG-001, Chapter 4, Section 10) may be scheduled as additional time for this EO.

REFERENCES

- A1-042 A-P9-050-000/PT-005 Director Training and Education Policy. (2001). *Canadian Forces Individual Training & Education System* (Vol. 5). Ottawa, ON: Department of National Defence.
- C1-133 (ISBN 0-9695066-2-7) Bender, P. (2000). *Secrets of Power Presentations*. Toronto, ON: The Achievement Group.
- C1-140 (ISBN 1-890460-02-8) Jenson, E. (1999). *Super Teaching: Mastering Strategies for Building Trainee Success*. San Diego, CA: The Brain Store Inc.

THIS PAGE INTENTIONALLY LEFT BLANK



COMMON TRAINING
PROFICIENCY LEVEL THREE
INSTRUCTIONAL GUIDE



SECTION 7

EO M309.07 – INSTRUCT A 15-MINUTE LESSON

Total Time:

90 min

PREPARATION

PRE-LESSON INSTRUCTIONS

Resources needed for the delivery of this lesson are listed in the lesson specification located in A-CR-CCP-803/PG-001, Chapter 4. Specific uses for said resources are identified throughout the instructional guide within the TP for which they are required.

Review the lesson content and become familiar with the material prior to delivering the lesson.

Photocopy the Instructional Techniques Assessment Form located at Annex AD for each cadet.

Ensure that all resources requested by the cadets are available.

PRE-LESSON ASSIGNMENT

N/A.

APPROACH

A practical activity was chosen for this lesson as it is an interactive way for cadets to develop instructional skills in a safe and controlled environment.

INTRODUCTION

REVIEW

N/A.

OBJECTIVES

By the end of this lesson the cadet shall have instructed a 15-minute lesson using a lesson plan, an appropriate method of instruction and an appropriate instructional aid.

IMPORTANCE

It is important for cadets to instruct a 15-minute lesson as it gives them the opportunity to practice instructional techniques in a peer setting and to receive feedback to further develop their confidence.

Teaching Point 1**Have the Cadets Instruct a 15-Minute Lesson**

Time: 85 min

Method: Practical Activity

ACTIVITY

OBJECTIVE

The objective of this activity is to have the cadets instruct a 15-minute lesson in a peer setting using a lesson plan, an appropriate method of instruction and an appropriate instructional aid.

RESOURCES

- Presentation aids (eg, whiteboard/flip chart/OHP) appropriate for the classroom/training area, and
- Instructional Techniques Assessment Form.

ACTIVITY LAYOUT

N/A.

ACTIVITY INSTRUCTIONS

1. Have the cadets provide a copy of their lesson plan to the assessor.
2. Determine the order in which cadets will instruct their lessons.
3. Have one cadet prepare the classroom/training area for their lesson.
4. Have one cadet instruct a 15-minute lesson using a written lesson plan, an appropriate method of instruction and an appropriate instructional aid (as prepared in EO M309.06 [Plan a Lesson, Section 6]).
5. Assess the cadet's lesson using the Instructional Techniques Assessment Form.
6. Upon completion of the lesson, provide feedback to the cadet.
7. Repeat Steps 3. to 6. until all cadets have instructed a lesson.



The Instructional Techniques Assessment Form located at Annex AD is used to provide feedback on the cadet's lesson and to introduce the cadet to the type of instructional techniques assessment they will receive in their future level training. The grey areas of the form are those applicable to the 309 PC (eg, the standard required for the achievement of PO 309). The remainder of the form is intended solely for the purposes of assessment for learning, providing the cadets with the feedback they need to improve their skills.

8. Debrief the cadets by providing feedback, focusing on:
 - a. best practices,
 - b. general trends and key areas for improvement, and
 - c. re-motivation, highlighting the effort and accomplishments of the group.



If the group of cadets is large, divide them up into smaller groups and assign other instructors to aid with assessment and feedback.

SAFETY

N/A.

CONFIRMATION OF TEACHING POINT 1

The cadets' participating in the activity will serve as the confirmation of this TP.

END OF LESSON CONFIRMATION

The cadets' instructing a 15-minute lesson will serve as the confirmation of this lesson.

CONCLUSION

HOMEWORK/READING/PRACTICE

N/A.

METHOD OF EVALUATION

This EO is assessed IAW A-CR-CCP-803/PG-001, Chapter 3, Annex B, Appendix 3 (309 PC).

CLOSING STATEMENT

Practicing instructional skills in a peer setting allows for the development of skills necessary to become a competent instructor while further developing confidence and a sense of accomplishment.

INSTRUCTOR NOTES/REMARKS

Additional time for this EO is available in EO C309.03 (Instruct a 15-Minute Lesson, A-CR-CCP-803/PG-001, Chapter 4, Section 10).

REFERENCES

A1-041 A-P9-050-000/PT-006 Director Training and Education Policy. (2002). *Canadian Forces Manual of Individual Training and Education* (Vol. 6). Ottawa, ON: Department of National Defence.

THIS PAGE INTENTIONALLY LEFT BLANK



COMMON TRAINING
PROFICIENCY LEVEL THREE
INSTRUCTIONAL GUIDE



SECTION 8

EO C309.01 – DELIVER A ONE-MINUTE VERBAL PRESENTATION

Total Time:	60 min
-------------	--------

PREPARATION

PRE-LESSON INSTRUCTIONS

Resources needed for the delivery of this lesson are listed in the lesson specification located in A-CR-CCP-803/PG-001, Chapter 4. Specific uses for said resources are identified throughout the instructional guide within the TP for which they are required.

Review the lesson content and become familiar with the material prior to delivering the lesson.

Photocopy the list of topics located at Annex AE and the verbal presentation feedback form located at Annex AF for each cadet.

PRE-LESSON ASSIGNMENT

N/A.

APPROACH

A group discussion was chosen for TP 1 as it allows the cadets to interact with their peers and share their knowledge, experiences, opinions and feelings about public speaking.

An interactive lecture was chosen for TP 2 as it allows the instructor to explain the expectations of the cadets for the one-minute verbal presentation.

A practical activity was chosen for TP 3 as it is an interactive way to help the cadets develop effective-speaking skills in a safe and controlled environment.

INTRODUCTION

REVIEW

Review EO M309.03 (Describe Effective-Speaking Techniques, Section 3).

OBJECTIVES

By the end of this lesson the cadet shall have delivered a one-minute verbal presentation.

IMPORTANCE

It is important for cadets to practice effective-speaking techniques because this will develop the skills required to present information and build the self-confidence needed to speak in front of others.

Teaching Point 1**Review Effective-Speaking Techniques**

Time: 15 min

Method: Group Discussion

BACKGROUND KNOWLEDGE

The purpose of the group discussion is to draw the following information from the group using the tips for answering/facilitating discussion and the suggested questions provided.

ELEMENTS OF VOICE CONTROL

One of the most important and effective tools of communication is voice control. The ability to use voice control to communicate effectively and place emphasis on important information is a fundamental skill that will be used while in front of an audience.

Pitch. How high or low a voice is. A change in pitch usually does not add any significance to a message however a pitch change will be noticed by the audience and will keep people involved.

Tone. The quality of the sound of a voice. Effective communicators will often change the tone of their voice to give emphasis to a single word or phrase to convey emotion and conviction.



Monotone. A sound without change of pitch or tone.

Volume. The quantity or power of sound or fullness of tone. A change in volume often signifies emphasis on a particular phrase or point. Environmental factors such as outside noise and room size must be taken into consideration to ensure the audience can hear the message being sent.

Speed. The rate or rapidity in which words are spoken. Speaking too fast or too slow can be distracting to an audience. It is important to communicate at a pace that ensures the audience can understand every word being said.

Pause. A break in speaking or reading. A pause is an important part of the communication process. A pause gives the audience an opportunity to digest what has been said and to ask questions. A pause is also an effective way to announce a change in subject or an important point.

Articulation. The clear and distinct pronunciation of a word. It is important to properly pronounce and articulate words to ensure the audience can understand the message being sent.

ELEMENTS OF PHYSICAL PRESENCE

It is estimated that 93 percent of the total meaning of a message comes from non-verbal communication and only 7 percent of meaning comes from the words themselves. Being aware of physical presence and its effect on a message being sent is an important element of effective communication.

Body Language

Body language or non-verbal communication is the process of communicating through conscious and unconscious gestures and expressions. Understanding that body language affects how a message is received and interpreted is an important tool for communicating effectively.

Facial expressions. While 93 percent of the total meaning of a message comes from non-verbal communication, most of that meaning is communicated by the eyes, eyebrows and mouth. The movement of the eyes, eyebrows and mouth can result in an infinite variety of expressions to complement the spoken word. It is important that facial expressions match the tone of the message being sent to create emphasis and believability. A smile is the most important of all facial expressions. A smile adds sincerity to a message and will add to the likeability of the individual in front of the audience.

Eye Contact. Maintaining eye contact is an effective way of engaging an audience and building interest. Pausing two or three seconds on each member of the audience will make them feel as though they are involved in a one-on-one conversation. It is important to look at the entire room and scan from left to right, back to front.



Look for friendly, sympathetic faces to gain confidence and ease nervousness.

Gestures. The combination of hand, arm and shoulder movements can make a wide variety of gestures that can help add meaning to a message. Effective communicators will let their hands and arms move naturally to help give emphasis and emotion to a message. It is important not to point directly at members of the audience or let gestures become distracting.

Movement. Being aware of movement while in front of an audience is very important to communication. Movement will keep listeners engaged and interested in what is being said. Moving around the front of the room, toward and away from an audience and from side to side can help emphasize points. Too much or frantic movement can become distracting and will affect how a message is received.



Hands placed in pockets are typically a sign of nervousness or overconfidence.

Dress and Deportment

Effective communicators are constantly aware of their dress and deportment. Audiences will react differently to an individual who is well dressed and acts professionally when in front of them, than an individual who is poorly dressed and acts unprofessionally.

Dress. Effective communicators will always appear in clean, well-pressed and appropriate attire. Dressing appropriately for the event will help create confidence and credibility.

Deportment. An audience that sees an individual as being prepared, on time, appropriately dressed and confident will be much more receptive, than to an individual who is unprepared, late, poorly dressed and nervous. The most important element of deportment is displaying an interest in the subject; this will be noticed by the audience and will generate interest in the presentation.

PREPARATION

Effective speaking preparation is the most critical component of effective communication. Preparation will help ensure confidence, control nervousness and increase the likelihood of success when in front of an audience.

The following are the steps to effective-speaking preparation:

1. **Practicing.** Proper rehearsal will aid in memorizing content, which will allow for more eye contact and movement while in front of an audience. Memorizing the introduction and conclusion are the two most critical elements; a strong introduction will aid in gaining confidence and will draw the interest of the

audience, a strong conclusion will aid in leaving a lasting impression on the audience. If possible, practice in front of a small group, speak aloud even when practicing alone and always practice while standing.

2. **Controlling Nervousness.** The feeling of nervousness prior to speaking in front of a group is normal and often can help if channeled effectively. The following actions can be taken to control nervousness:
 - a. **Room Layout.** Become familiar with the layout of the room prior to speaking.
 - b. **Materials.** Ensure notes, handouts and presentation aids are organized.
 - c. **Equipment.** Ensure any equipment being used is in working order and ready to use.
 - d. **Practice.** Spend time going over notes and rehearsing content.
 - e. **Attitude.** Enter the room with a smile and a positive and confident attitude.
 - f. **Breathing.** Take a deep breath before entering the room. Slow down the delivery if necessary and breathe from the diaphragm while speaking, not from the chest.
3. **Identifying a Friendly Face.** While walking in front of an audience, identify a friendly face. Making eye contact with a friendly face while beginning to speak will often give confidence while beginning the introduction and ultimately lead to success when addressing an audience.

GROUP DISCUSSION



TIPS FOR ANSWERING/FACILITATING DISCUSSION

- Establish ground rules for discussion, eg, everyone should listen respectfully; don't interrupt; only one person speaks at a time; no one's ideas should be made fun of; you can disagree with ideas but not with the person; try to understand others as much as you hope they understand you; etc.
- Sit the group in a circle, making sure all cadets can be seen by everyone else.
- Ask questions that will provoke thought; in other words avoid questions with yes or no answers.
- Manage time by ensuring the cadets stay on topic.
- Listen and respond in a way that indicates you have heard and understood the cadet. This can be done by paraphrasing their ideas.
- Give the cadets time to respond to your questions.
- Ensure every cadet has an opportunity to participate. One option is to go around the group and have each cadet answer the question with a short answer. Cadets must also have the option to pass if they wish.
- Additional questions should be prepared ahead of time.

SUGGESTED QUESTIONS

- Q1. How can voice be varied to maintain class interest?
- Q2. How does physical presence affect how a message is received?
- Q3. What is one of the most important elements of deportment?
- Q4. What are some ways for controlling nervousness?



Other questions and answers will develop throughout the group discussion. The group discussion should not be limited to only those suggested.



Reinforce those answers given and comments made during the group discussion, ensuring the teaching point has been covered.

Teaching Point 2

Explain the Expectations of the One-Minute Verbal Presentation

Time: 10 min

Method: Interactive Lecture

EXPECTATIONS OF THE ONE-MINUTE VERBAL PRESENTATION

The expectations of the one-minute verbal presentation are to practice the following skills:

1. using effective speaking techniques to communicate ideas; and
2. speaking clearly and confidently in front of a group of peers.

Instructions

1. Each cadet is required to deliver a one-minute verbal presentation on a topic chosen from the list located at Annex AE.
2. Each cadet is permitted to use one piece of paper not larger than 8 1/2 inches by 11 inches for outline notes. Cadets are not permitted to read their presentations directly from the paper.
3. Cadets will not be given assistance during their presentations other than the signal from the timekeeper.
4. Cadets will be given feedback using the feedback form located at Annex AF. The feedback positively emphasizes what the cadet did well and areas for improvement.
5. Aids such as a podium, OHP or flip charts should be made available (where possible), if requested by the cadet, prior to the presentation.
6. A timekeeper will be present to signal the cadet when they are nearing the one-minute mark.



Hand out the list of topics located at Annex AE and have the cadets choose what topic they will speak about.

Hand out the Verbal Presentation Feedback Form located at Annex AF to each cadet and discuss how it will be used.

CONFIRMATION OF TEACHING POINT 2

QUESTIONS

- Q1. What is the aim of the one-minute verbal presentation?

Q2. When should aids required for the presentation be requested?

ANTICIPATED ANSWERS

A1. To practice the skills for effectively communicating ideas by speaking clearly and confidently.

A2. Prior to the presentation.

Teaching Point 3

Conduct an Activity Where the Cadets Will Deliver a One-Minute Verbal Presentation

Time: 25 min

Method: Practical Activity



This activity should be conducted on a separate training night from TP 1 & 2 to allow the cadets an opportunity to prepare their verbal presentations.

ACTIVITY

OBJECTIVE

The objective of this activity is to have the cadets deliver a one-minute verbal presentation.

RESOURCES

- Presentation aids (eg, whiteboard/flip chart/OHP) appropriate for the classroom/training area,
- Other presentation aids as requested by the cadets, and
- Verbal Presentation Feedback Form.

ACTIVITY LAYOUT

N/A.

ACTIVITY INSTRUCTIONS



During the activity:

- Use the Verbal Presentation Feedback Form located at Annex AF to record feedback on what the cadet has done well and areas for improvement.
- Ensure that the requested presentation aids are available prior to the start of the activity.
- Ensure that a timekeeper is present to signal the cadets when they near the one-minute mark. If the cadets go over time, note this in their feedback. Abruptly cutting them off may be more damaging than the negative feedback.

1. Brief the cadets on the following instructions for this activity:

- a. Each cadet is required to deliver a one-minute verbal presentation on a chosen topic.

- b. Each cadet is permitted to use one piece of paper not larger than 8 1/2 inches by 11 inches for outline notes. Cadets are not permitted to read their presentations directly from the paper.
 - c. No assistance will be provided.
2. Determine the order in which the cadets will deliver their presentations.
 3. Have each cadet deliver a presentation. At the end of the presentation, provide one-on-one feedback to the cadet using the Verbal Presentation Feedback Form (Annex AF). Have the next cadet prepare for their presentation while the one-on-one feedback interview is in progress.



Instructions for the one-on-one feedback interview:

1. Conduct in a private setting.
2. Put the cadet at ease.
3. Ask how they think they did.
4. Ask what they think went well. Discuss two positive points about their presentation.
5. Ask what they think needs improvement. Discuss two areas for improvement.
6. Finish the feedback interview on a positive note.

Positive feedback is essential and should take into account that this may be the first time the cadet has delivered a prepared presentation in front of a group.

4. Continue until all the cadets have had the opportunity to present.
5. Summarize the common feedback for the group and discuss how to improve the presentations.



It is essential that the cadets leave the lesson with a positive attitude.

SAFETY

N/A.

CONFIRMATION OF TEACHING POINT 3

The cadets' participation in a one-minute verbal presentation will serve as confirmation for this TP.

END OF LESSON CONFIRMATION

The cadets' participation in a one-minute verbal presentation will serve as confirmation for this lesson.

CONCLUSION

HOMEWORK/READING/PRACTICE

N/A.

METHOD OF EVALUATION

N/A.

CLOSING STATEMENT

Practicing effective speaking techniques in front of peers will build self-confidence and develop presentation skills needed for instructing cadets.

INSTRUCTOR NOTES/REMARKS

TP 3 should be scheduled on a separate training night after TPs 1 and 2 have been conducted.

This EO should be scheduled after EO M309.03 (Employ Effective Speaking Techniques, Section 3) and before EO M309.06 (Plan a Lesson, Section 6).

REFERENCES

C1-133 (ISBN 0-9695066-2-7) Bender, P. (2000). *Secrets of Power Presentations*. Toronto, ON: The Achievement Group.



**COMMON TRAINING
PROFICIENCY LEVEL THREE
INSTRUCTIONAL GUIDE**



SECTION 9

EO C309.04 – IDENTIFY FORMATIONS FOR DRILL INSTRUCTION

Total Time:	30 min
-------------	--------

PREPARATION

PRE-LESSON INSTRUCTIONS

Resources needed for the delivery of this lesson are listed in the lesson specification located in A-CR-CCP-803/PT-001, Chapter 4. Specific uses for said resources are identified throughout the instructional guide within the TP for which they are required.

Review the lesson content and become familiar with the material prior to delivering the lesson.

PRE-LESSON ASSIGNMENT

N/A.

APPROACH

An interactive lecture was chosen for TP 1 to introduce the formations used for drill instruction.

A demonstration was chosen for TP 2 as it allows the instructor to demonstrate the procedures for forming a hollow square and reforming the squad.

INTRODUCTION

REVIEW

N/A.

OBJECTIVES

By the end of this lesson the cadet shall have identified the formations for drill instruction.

IMPORTANCE

It is important for cadets to identify formations for drill instruction to be able to select the most effective formation for the lesson being taught. The choice of formation is important because it allows all of the cadets to see the instructor.

Teaching Point 1

Describe the Formations for Drill Instruction

Time: 5 min

Method: Interactive Lecture

FORMATIONS FOR DRILL INSTRUCTION

The choice of formation is important because it allows all of the cadets to see the instructor. The three formations that are recommended are a single file, a semicircle and a hollow square.

Single File. Used for groups of five cadets or less which can form up into one rank.

Semicircle. Used for groups of six to nine cadets which can be formed up in two ranks. There is no formal drill command for forming a semicircle.

Hollow Square. Used for groups of 10 or more cadets which are formed up in three ranks.

CONFIRMATION OF TEACHING POINT 1

QUESTIONS

- Q1. When is a single file formation used?
- Q2. What formation should be used for a squad in two ranks?
- Q3. How many ranks must the squad be in to form a hollow square?

ANTICIPATED ANSWERS

- A1. Groups of five cadets or less.
 - A2. Semicircle.
 - A3. Three ranks.
-

Teaching Point 2

Demonstrate the Procedure for Forming a Hollow Square and Reforming a Squad

Time: 20 min

Method: Demonstration



Proper drill movements shall be combined with a professional demeanour throughout the period of instruction.

Check for faults and correct them immediately when they occur.



Capitalization indicates the words of command for each movement.

FORM HOLLOW SQUARE



The squad shall be in line in three ranks prior to forming the hollow square.

The following procedure is used to form a hollow square (as illustrated in Figure 9-9-1):

1. On the command FORM HOLLOW SQUARE, CENTRE RANK RIGHT, REAR RANK LEFT-TURN, the squad acts as ordered.
2. On the command CENTRE RANK LEFT WHEEL, REAR RANK RIGHT WHEEL, QUICK-MARCH, the squad acts as ordered.
3. The command MARK-TIME shall be given when the rear individuals of the centre and rear ranks are one pace in front of the front rank.
4. On the command SQUAD-HALT, the squad acts as ordered.
5. On the command CENTRE RANK LEFT, REAR RANK RIGHT-TURN, the squad acts as ordered.

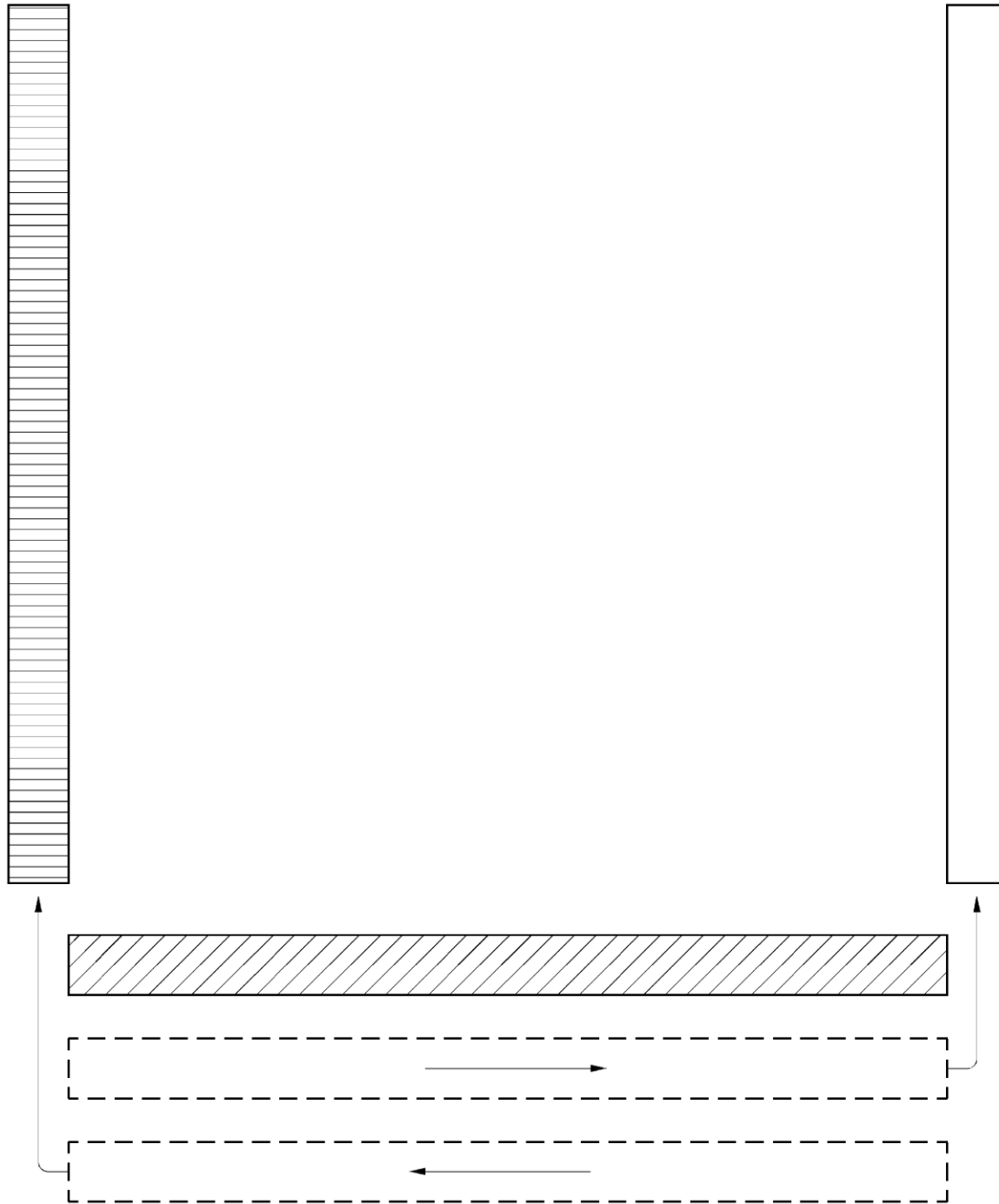

A-PD-201-000/PT-000 (p. 3-23)

Figure 9-9-1 Forming a Hollow Square

REFORM THREE RANKS

 The reverse procedure to forming a hollow square is used to reform a squad into three ranks.

The following procedure is used to reform three ranks:

1. On the command REFORM THREE RANKS, CENTRE RANK LEFT, REAR RANK RIGHT-TURN, the squad acts as ordered.
2. On the command CENTRE RANK RIGHT WHEEL, REAR RANK LEFT WHEEL, QUICK-MARCH, the squad acts as ordered.
3. The command MARK-TIME shall be given when the squad has reformed three ranks.
4. On the command SQUAD-HALT, the squad acts as ordered.
5. On the command CENTRE RANK RIGHT, REAR RANK LEFT-TURN, the squad acts as ordered.



If time permits, have the cadets practice forming a hollow square with their peers. Simulate three ranks for groups less than 10 cadets.

CONFIRMATION OF TEACHING POINT 2

QUESTIONS

- Q1. How must a squad be formed before forming a hollow square?
- Q2. When should the instructor give the command to mark time when forming a hollow square?
- Q3. What procedure is used to reform three ranks?

ANTICIPATED ANSWERS

- A1. In three ranks.
- A2. The rear individuals of the centre and rear ranks are one pace in front of the front rank.
- A3. The reverse procedure to forming a hollow square.

END OF LESSON CONFIRMATION

QUESTIONS

- Q1. What three formations are used for drill instruction?
- Q2. What formation should be used for a group of seven cadets?
- Q3. How many cadets are needed to form a hollow square?

ANTICIPATED ANSWERS

- A1. Single file, semicircle and hollow square.
- A2. Semicircle.
- A3. 10 or more.

CONCLUSION

HOMEWORK/READING/PRACTICE

N/A.

METHOD OF EVALUATION

N/A.

CLOSING STATEMENT

Drill instruction requires the instructor to demonstrate each individual squad of a movement so the cadets can see what is expected. The choice of formation is important because it allows all of the cadets to see the instructor.

INSTRUCTOR NOTES/REMARKS

N/A.

REFERENCES

A0-002 A-PD-201-000/PT-000 Director History and Heritage 3-2. (2005). *The Canadian Forces Manual of Drill and Ceremonial*. Ottawa, ON: Department of National Defence.



**COMMON TRAINING
PROFICIENCY LEVEL THREE
INSTRUCTIONAL GUIDE**



SECTION 10

EO C309.05 – PLAN A DRILL LESSON

Total Time: 60 min

PREPARATION

PRE-LESSON INSTRUCTIONS

Resources needed for the delivery of this lesson are listed in the lesson specification located in A-CR-CCP-803/PG-001, Chapter 4. Specific uses for said resources are identified throughout the instructional guide within the TP for which they are required.

Review the lesson content and become familiar with the material prior to delivering the lesson.

Photocopy Annexes AG to AJ for each cadet.

Photocopy the lesson specifications and instructional guides located at Annexes AK to AQ as required.

PRE-LESSON ASSIGNMENT

N/A.

APPROACH

An interactive lecture was chosen for TPs 1 and 2 to present the drill instruction sequence and to stimulate an interest in planning a drill lesson.

A practical activity was chosen for TP 3 to guide the cadets through the process of planning a drill lesson.

INTRODUCTION

REVIEW

N/A.

OBJECTIVES

By the end of this lesson the cadet shall have identified the drill instruction sequence and written a drill lesson plan.

IMPORTANCE

It is important for cadets to know the essential elements of a drill lesson and be able to develop a written drill lesson plan as it allows them to be better prepared to deliver drill instruction. Drill that is well taught and executed develops individual pride, mental alertness, precision and esprit de corps.

Teaching Point 1**Describe the Drill Instruction Sequence**

Time: 10 min

Method: Interactive Lecture

INTRODUCTION

The lesson shall be introduced as follows:

1. Order the squad into a suitable formation such as a single rank, hollow square or semicircle.
2. Review the previous lesson.
3. Describe the new movement.
4. Describe why it is important to learn the movement.
5. Describe where and when the movement will be used.
6. Describe how the cadets will be assessed.

BODY

The lesson shall be taught using the following process:

1. Demonstrate the complete movement, calling out the time.
2. Explain the complete movement.
3. Demonstrate the first part of the movement (Squad 1).
4. Explain the first part of the movement.
5. Give the squad the opportunity to ask questions.
6. Practice the first movement (collectively, individually, collectively) (as illustrated in Figure 9-10-1).
7. Demonstrate and explain the second part of the movement (Squad 2) and any subsequent parts of the movement (Squads) following Steps 3. to 6.
8. Give two complete demonstrations.
9. Practice the complete movement with:
 - a. the instructor calling the time;
 - b. the squad calling the time; and
 - c. the squad judging the time.

DEMONSTRATE THE COMPLETE MOVEMENT WITH TIMING

The instructor shall provide a complete demonstration of the drill movement, with timing. A practiced assistant instructor may carry out this demonstration.

The demonstration shall be provided from various vantage points, as required.

DEMONSTRATE FIRST PART OF MOVEMENT (FIRST NUMBER)

For ease of instruction, drill commands have been broken down into individual movements, or numbers. The instructor(s) shall demonstrate and explain each number.

In order to adopt the position of attention from stand at ease, the cadet shall:

On the command ATTENTION BY NUMBERS, SQUAD – ONE, bend the left knee and shift the balance to the right.

PRACTICE THE SQUAD ON THE FIRST MOVEMENT

Practice the squad on the first movement collectively, individually and collectively.

Director Cadets 3, 2008, Ottawa, ON: Department of National Defence

Figure 9-10-1 Drill Instruction Sequence

END OF LESSON CONFIRMATION

The end of lesson confirmation must meet the following criteria:

1. It shall be a performance of the movement taught.
2. It shall be conducted as a squad.
3. It will emphasize any aspects of the movement that the cadets experienced difficulty with during the lesson.

CONCLUSION

The lesson shall be summarized as follows:

1. Restate the movement taught and where or when it will be used;
2. Re-motivate the cadets by:
 - a. commenting on the cadets' progress; and
 - b. re-stating why the drill movement just learned is important.
3. Describe the next lesson.

CONFIRMATION OF TEACHING POINT 1

QUESTIONS

- Q1. Describe one action an instructor shall take during the introduction of a drill lesson.
- Q2. List the sequence for practicing drill movements.
- Q3. What shall an instructor do in the conclusion of a drill lesson?

ANTICIPATED ANSWERS

- A1. During the beginning of a drill lesson, an instructor shall:
1. Order the squad into a suitable formation.
 2. Review the previous lesson.
 3. Describe the new movement.
 4. Describe why it is important to learn it.
 5. Describe where and when the movement will be used.
 6. Describe how the cadets will be assessed.
- A2. The sequence for practicing drill movements is to practice the squad collectively, individually, collectively.
- A3. In the conclusion the instructor shall:
1. Restate the movement taught and where or when it will be used.
 2. Re-motivate the cadets by commenting on the cadets' progress and by re-stating the reason for learning the movement.
 3. Describe the next lesson.

Teaching Point 2

Review the Lesson-Planning Process

Time: 10 min

Method: Interactive Lecture



Before beginning the activity for planning a drill lesson, review the lesson-planning process taught in M309.06 (Plan a Lesson, Section 6) summarized below.



Distribute the lesson plan handout located at Annex AG to each cadet.

THE LESSON-PLANNING PROCESS

The Canadian Forces employs an initialism that is used to provide a framework for the instructor to gather and organize the reference material into an efficient and practical lesson plan. The initialism is CCSAM.

Collect. During this step, the instructor researches the material to be covered in the period of instruction using course documents such as the lesson specification, IG and listed references. In situations where no course documents exist, the instructor will research the material to be taught using whatever references exist.

Consider. During this step, the instructor sifts through all of the material found in the collection step and determines what is relevant and current.

Select. During this step, the instructor selects the material that is appropriate for the lesson. The instructor also selects the method of instruction to be used.

Arrange. During this step, the instructor arranges the material into stages that allow for the information to be presented in a logical sequence.

Master. During this step, the instructor writes the lesson plan.

LESSON SPECIFICATION

Lesson specifications are found in A-CR-CCP-803/PG-001, Chapter 4. The two sections of a lesson specification are the enabling objective (EO) and the lesson specification.

Enabling Objective

The EO is the first three paragraphs of the lesson specification and will answer three questions:

- What will the cadet be expected to be able to do by the end of this lesson?
- Under what conditions will the cadet be expected to carry out the performance?
- How well or to what standard will the cadet be expected to perform?

Lesson Specification

The lesson specification, (paragraphs 4. to 11.), contains information about:

- the content to be taught broken down into teaching points;
- the teaching method(s) to be used and why they were chosen;
- the time for each teaching point (TP);
- the references used;
- the training aids to be used;
- the learning aids to be used;
- the test details; and
- remarks for the instructor.

INSTRUCTIONAL GUIDE (IG)

The IG is used in conjunction with the QSP and other resources to conduct training. IGs should be reviewed in conjunction with lesson specifications so that the instructor can adequately plan and prepare their lesson. The following are the six sections of an IG:

Preparation. This section provides information to the instructor regarding:

- pre-lesson instructions;
- pre-lesson assignment; and
- instructional approach or method.

Introduction. This section provides information to the instructor regarding:

- any review that may be necessary;

- what the cadet will be expected to do by the end of the lesson; and
- why the knowledge/skill is important.

Body. This section provides information to the instructor regarding:

- the TPs and their content as listed in paragraph 4 of the lesson specification in greater detail;
- suggested teaching methods;
- note boxes with special instructions or information;
- lesson content;
- figures;
- activities; and
- confirmation questions or activities.

Conclusion. This section provides information to the instructor regarding:

- any homework/reading/practice that may be required of the cadet;
- the method of evaluation to be used as stated in the lesson specification;
- a closing statement to be spoken aloud to the cadet; and
- any additional instructor notes/remarks.

References. This section lists the sources of information used to create the lesson specification and instructional guide.

Annexes. This section contains background information for the TPs, pre-made instructional aids and additional information for activities.

CONFIRMATION OF TEACHING POINT 2

QUESTIONS

- Q1. List the five parts of the lesson-planning process.
- Q2. What is included in the EO portion of a lesson specification?
- Q3. What are the six sections of an instructional guide?

ANTICIPATED ANSWERS

- A1. The five parts of the lesson planning process are collect, consider, select, arrange and master.
- A2. The information included in the EO is what the cadet will be expected to learn, what materials, supervision and equipment will be available to the cadet and what standard the cadet will be expected to achieve.
- A3. The six sections of an IG are preparation, introduction, body, conclusion, references and annexes.

Teaching Point 3**Supervise and Provide Assistance While the Cadets Plan a Drill Lesson**

Time: 30 min

Method: Practical Activity

In EO C309.06 (Instruct a 15-Minute Drill Lesson, Section 11), the cadets shall be expected to instruct a drill lesson using a lesson plan, the drill instruction sequence and the appropriate drill formation. The lesson plan created in this EO will be used to instruct that drill lesson.



Distribute the blank lesson plan located at Annex AH and the plan a drill lesson checklist located at Annex AI to each cadet.

ACTIVITY**OBJECTIVE**

The objective of this activity is to have the cadets plan a 15-minute drill lesson.

RESOURCES

- List of approved 15-minute drill topics located at Annex AJ, and
- Modified lesson specifications and instructional guides located at Annexes AK to AQ.

ACTIVITY LAYOUT

N/A.

ACTIVITY INSTRUCTIONS

1. Have each cadet choose a topic from the list of approved 15-minute drill topics.
2. Have the cadets use the lesson specification and IG for their chosen topic to help develop their drill lesson plan. Cadets shall be expected to teach their chosen lesson as part of C309.06 (Instruct a 15-Minute Drill Lesson, Section 11).
3. Circulate around the room facilitating the activity and helping the cadets as required.



Ensure that cadets request all resources required to instruct their lesson.

SAFETY

N/A.

CONFIRMATION OF TEACHING POINT 3

The cadets' participation in the activity will serve as the confirmation of this TP.

END OF LESSON CONFIRMATION

The cadets' planning a drill lesson will serve as the confirmation of this lesson.

CONCLUSION

HOMEWORK/READING/PRACTICE

The cadets shall be prepared to instruct their lesson at the beginning of C309.06 (Instruct a 15-Minute Lesson, Section 11).

METHOD OF EVALUATION

N/A.

CLOSING STATEMENT

Instructors must continually work to improve the quality of instruction. Being able to plan drill lessons is a critical step in boosting the instructor's confidence and improving the quality of drill instruction.

INSTRUCTOR NOTES/REMARKS

EO C309.05 (Plan a Drill Lesson, Section 10) should be scheduled at least one week prior to EO C309.06 (Instruct a 15-Minute Drill Lesson, Section 11).

REFERENCES

A0-002 A-PD-201-000/PT-000 Director History and Heritage 3-2. (2005). *The Canadian Forces Manual of Drill and Ceremonial*. Ottawa, ON: Department of National Defence.



COMMON TRAINING
PROFICIENCY LEVEL THREE
INSTRUCTIONAL GUIDE



SECTION 11

EO C309.06 – INSTRUCT A 15-MINUTE DRILL LESSON

Total Time:

90 min

PREPARATION

PRE-LESSON INSTRUCTIONS

Resources needed for the delivery of this lesson are listed in the lesson specification located in A-CR-CCP-803/PG-001, Chapter 4. Specific uses for said resources are identified throughout the instructional guide within the TP for which they are required.

Review the lesson content and become familiar with the material prior to delivering the lesson.

Photocopy the Drill Instructional Techniques Assessment Form located at Annex AR for each cadet.

Ensure that all resources requested by the cadets are available.

PRE-LESSON ASSIGNMENT

N/A.

APPROACH

A practical activity was chosen for this lesson as it is an interactive way for cadets to develop drill instructional skills in a safe and controlled environment.

INTRODUCTION

REVIEW

N/A.

OBJECTIVES

By the end of this lesson the cadet shall have instructed a 15-minute drill lesson using a written lesson plan and the drill instruction sequence.

IMPORTANCE

It is important for cadets to instruct a 15-minute drill lesson as it gives them the opportunity to practice drill instructional skills in a peer setting and to receive feedback to further develop instructional skills and confidence.

Teaching Point 1**Supervise While the Cadets Instruct a 15-Minute Drill Lesson**

Time: 85 min

Method: Practical Activity

ACTIVITY

Time: 85 min

OBJECTIVE

The objective of this activity is to have cadets instruct a 15-minute drill lesson in a peer setting using a written lesson plan and the drill instruction sequence.

RESOURCES

Drill Instructional Techniques Assessment Form.

ACTIVITY LAYOUT

N/A.

ACTIVITY INSTRUCTIONS

1. Have the cadets provide a copy of their lesson plan to the assessor.
2. Determine the order in which cadets will instruct their lessons.
3. Have one cadet form up the squad for their drill lesson.
4. Have one cadet instruct a 15-minute drill lesson using a written lesson plan and the drill instruction sequence (as prepared in EO C309.05 [Plan a Drill Lesson, Section 10]).
5. Assess the cadet's lesson using the Drill Instructional Techniques Assessment Form.
6. Upon completion of the lesson, provide feedback to the cadet.
7. Repeat Steps 3. to 6. until all cadets have instructed a lesson.



The Drill Instructional Techniques Assessment Form located at Annex AR is used to provide feedback on the cadet's lesson and to introduce the cadet to the type of instructional techniques assessment they will receive in their future level training. The form is intended solely for the purposes of assessment for learning, providing the cadets with the feedback they need to improve upon their own skills.

8. Debrief the cadets by providing feedback, focusing on:
 - a. best practices,
 - b. general trends and key areas for improvement, and
 - c. re-motivation, highlighting the effort and accomplishments of the group.



If the group of cadets is large, divide them up into smaller groups and assign other instructors to aid with assessment and feedback.

SAFETY

N/A.

CONFIRMATION OF TEACHING POINT 1

The cadets' participation in the activity will serve as the confirmation of this TP.

END OF LESSON CONFIRMATION

The cadet's instructing a 15-minute drill lesson will serve as the confirmation of this lesson.

CONCLUSION

HOMEWORK/READING/PRACTICE

N/A.

METHOD OF EVALUATION

N/A.

CLOSING STATEMENT

Practicing drill instructional skills in a peer setting allows for the development of fundamental skills necessary to become a drill instructor while further developing confidence and providing a sense of accomplishment.

INSTRUCTOR NOTES/REMARKS

This EO shall be conducted after EO C309.04 (Identify Formations for Drill Instruction, Section 9) and EO C309.05 (Plan a Drill Lesson, Section 10).

Additional time may be required for class sizes greater than five cadets.

REFERENCES

A0-002 A-PD-201-000/PT-000 Director Heritage and History 3-2 (2005). *The Canadian Forces Manual of Drill and Ceremonial*. Ottawa, ON: Department of National Defence.

THIS PAGE INTENTIONALLY LEFT BLANK

PRINCIPLES OF INSTRUCTION INFORMATION SHEET

INTEREST

Cadets are more receptive to learning when they are curious and have an emotional connection to a topic. The instructor must arouse, create and maintain the interest of the cadets. Without interest, the cadets will be less inclined to listen and will not learn.

- **Principle.** People learn when they are interested in the material or skill.
- **Action.** Instructors must arouse, create and maintain the cadets' interest. The instructor should employ imaginative means to keep curiosity, while taking into account experience and interests.

Ensure Interest	Technique
Information	Inform the cadets why they are learning the skill or knowledge. Explain all of the benefits of this new knowledge or skill.
Enthusiasm	Show enthusiasm. Smile and have fun. Make eye contact. Vary the pitch, resonance, articulation, speed, volume, inflection and rhythm of your speech.
Variety	Use more than one instructor. Use verbal support to back up a statement or to clarify an idea. Use a variety of different training aids. Try different teaching methods.
Realism	Try a different location for your class. If you are teaching meteorology, go outside and look at the clouds, etc.
Participation	Involve the cadets by asking questions. Ensure cadets participate early in a skill lesson. Use speed and/or ability competitions or games to reinforce learning.

COMPREHENSION

Comprehension or understanding relates to the cadet's ability to understand the material taught. The cadets' readiness to learn new material is influenced by what has previously been taught; new content should not exceed the knowledge level of the cadets. If the cadets do not understand, they are unable to learn.

- **Principle.** People learn when instruction starts at their level of understanding and proceeds at the rate of their comprehension.
- **Action.** Instructors must determine the cadet's level of knowledge and only progress with new material when the cadets have full understanding of the material previously taught.

Ensure Comprehension	Technique
Research	Examine the Qualification Standard and Plan (QSP) to determine what material the cadets have already been taught.
Plan	Organize lesson material in a logical order. Proceed from the known to the unknown. Move from simple material to the more difficult.
Question	Ask review questions at the start of the lesson to determine the level of understanding. Continue to ask questions throughout the lesson to ensure understanding. Assure cadets early in the lesson that questions are welcome.
Observe	Watch for expressions of body language that may indicate difficulty with parts of the lesson. Observe cadets when they practice a skill and correct error as they occur.

EMPHASIS

During a period of instruction there will be some information, which may be of particular importance. The instructor can emphasize this important information through the use of voice control, training aids and in-class activities.

- **Principle.** People retain more important information when the instructor uses repetition and emphasis.
- **Action.** Instructors must stress essential points.

Ensure Emphasis	Technique
Process	Teach the material step by step. Re-cap each area (stress key points). Have the cadets take notes.
In-Class Review	Review the key points from the past lesson. Repeat the key points during the lesson.
Reinforcement	For a knowledge lesson, ask questions on the key points. For a skill lesson, allow sufficient practice time for the cadets to ask questions and receive corrective action. Do not over demonstrate. Try saying "This is important, remember it." Use verbal support by giving examples, to include: <ul style="list-style-type: none"> • comparisons, • reasons, • restatement and repetition, • examples, • statistics, and • testimonials. Use training aids.
Post Lesson	Distribute handouts covering key points.

PARTICIPATION

Cadets are more likely to retain information if they are both mentally and physically involved in learning. The instructor should conduct activities that contain action, activity and excitement. Cadets learn by doing.

- **Principle.** People learn best when they have an opportunity to participate actively in the learning process. People learn by doing.
- **Action.** The instructor creates class participation in the form of a physical or mental activity.

Ensure Participation in a Knowledge Lesson	Technique
Involvement	Ask open-ended questions that will encourage individual thought and generate a discussion.
Group Work	Select teaching methods that allow the cadets to share ideas and knowledge.
Learning Activity	Organize teaching points to contain such things as: <ul style="list-style-type: none"> • puzzles, • crosswords, • trivia games, • board games, • word searches, • discussions, • case studies, • competitions, • experiments, or • problem solving.
Application	Allow the cadets to apply the knowledge through case studies and problem-based learning.

Ensure Participation in a Skill Lesson	Technique
Involvement	Ensure early involvement by cadets. Have as many cadets as possible working on the skills at the same time.
Practice	Ensure ample practice time. Maintain close supervision during practice

Ensure Participation in a Skill Lesson	Technique
Detection and Correction	Be aware of commonly made errors while practicing a new skill. Observe cadets closely when they practice a skill. Correct errors as they occur. Correct one error at a time.
Competition	Allow the cadets to practice new skills by conducting friendly competitions and contests.

ACCOMPLISHMENT

The lesson must impart a sense of accomplishment to each cadet. The cadets should leave the class with the satisfaction that they were able to achieve something in the lesson.

- **Principle.** People learn most effectively when their performance results in a sense of accomplishment.
- **Action.** The instructor must tell the cadets what they are doing well and what needs improvement. The objective is to offer feedback that will reinforce desired performance and correct undesired performance.

Ensure Accomplishment	Technique
Expectations	Inform cadets of the lesson objectives. Ensure the cadets understand what will be expected of them at the end of the lesson.
Learner Satisfaction	Explain lessons clearly using simple words. The cadets will learn easily creating fulfillment.
Learner Responsibility	Keep cadets informed of their progress. Just by saying “Now that you have all correctly created a lean-to, let’s practice erecting a tent” will indicate the cadets’ progress.
Encouragement	Reassure cadets that they will be successful. Compliment cadets on work that is well done.
Perseverance	Encourage cadets who may be having difficulty. Allow cadets to practice skills they have difficulty with. Offer extra help if necessary.

CONFIRMATION

Confirmation is an essential part of learning and instructing. It gives both the instructor and the cadet the opportunity to see how well the information is understood.

- **Principle.** Confirm that learning has occurred and knowledge has been retained.
- **Action.** Instructors must confirm that the cadets' learning meets established standards and ensure that the skills can be performed safely and competently.

Ensure Confirmation	Technique
Practice	Observe as the cadets practice the skills.
Exercise	Have the cadets perform the skill. If you are teaching cadets how to use the phonetic alphabet, listen to each cadet perform the letters. Anyone who cannot do it may need extra instruction. Provide exercises or guide discussions that stress the key points of the lesson.
Questions	Ask questions at the end of the lesson to assess how well the cadets are learning. Listen carefully to the cadets' answers. You may be able to identify weak areas that may need to be re-taught.
Assignments	Review assignments completed outside class to determine the extent of learning.
Tests	Conduct confirmation for teaching points and enabling checks. This will also reinforce learning.
Observations	Note and provide feedback on cadet behaviour.

PRINCIPLES OF INSTRUCTION WORKSHEETS

PRINCIPLES OF INSTRUCTION Worksheet

NAME OF PRINCIPLE: Interest.

TOPIC: How to eat an apple.

TECHNIQUES FOR APPLYING THE PRINCIPLE TO THIS TOPIC:

PRINCIPLES OF INSTRUCTION Worksheet

NAME OF PRINCIPLE: Comprehension.

TOPIC: How to tie a shoe.

TECHNIQUES FOR APPLYING THE PRINCIPLE TO THIS TOPIC:

PRINCIPLES OF INSTRUCTION Worksheet

NAME OF PRINCIPLE: Emphasis.

TOPIC: How to cross the street.

TECHNIQUES FOR APPLYING THE PRINCIPLE TO THIS TOPIC:

PRINCIPLES OF INSTRUCTION Worksheet

NAME OF PRINCIPLE: Participation.

TOPIC: How to walk down the stairs.

TECHNIQUES FOR APPLYING THE PRINCIPLE TO THIS TOPIC:

PRINCIPLES OF INSTRUCTION

Worksheet

NAME OF PRINCIPLE: Accomplishment.

TOPIC: How to work a zipper.

TECHNIQUES FOR APPLYING THE PRINCIPLE TO THIS TOPIC:

PRINCIPLES OF INSTRUCTION

Worksheet

NAME OF PRINCIPLE: Confirmation.

TOPIC: How to throw a ball.

TECHNIQUES FOR APPLYING THE PRINCIPLE TO THIS TOPIC:

METHODS OF INSTRUCTION

INTERACTIVE LECTURE

Description	Pre-Lesson Preparation	Typical Applications	Lesson Development
<p>Interactive lecture is an instructor-driven method, which combines both lecture and interaction to meet lesson objectives. The lecture portions of the lesson are offset with relevant activities such as videos with discussion, games, learning stations, brainstorming, debating, group work or the completion of handouts.</p>	<p>Use attention-getters such as interesting facts, statistics or rhetorical questions to begin the lecture or to introduce new teaching points.</p> <p>Prepare participatory questions to encourage cadet participation.</p> <p>Prepare evaluative questions for confirmation of teaching points.</p> <p>Obtain or develop training aids to clarify main points.</p> <p>Prepare an in-class activity to avoid lecturing too long.</p> <p>Practice delivering the material.</p>	<p>Interactive lectures can be used with different sizes of groups to:</p> <ul style="list-style-type: none"> • introduce a subject; • present background information; • review previously taught material; • give instructions on procedures; • illustrate the application of rules, principles or concepts; or • introduce a demonstration, discussion or performance. 	<p>Begin the lesson and each new TP with an attention-getter.</p> <p>Use presentation aids such as:</p> <ul style="list-style-type: none"> • flip chart, • whiteboard, and/or • electronic media. <p>Pay attention to signals of alertness, such as:</p> <ul style="list-style-type: none"> • cadets' facial expressions, and • cadets' body language. <p>Deal with alertness problems by:</p> <ul style="list-style-type: none"> • asking for questions; and • posing questions to the group. <p>Use visual training aids at opportune moments.</p> <p>Integrate interesting facts with lesson material to maintain interest.</p> <p>Use participatory questions or a short activity to avoid lecturing too long.</p> <p>Use questions to confirm each teaching point.</p> <p>Confirm the lesson using questions or an activity.</p>

DEMONSTRATION AND PERFORMANCE

Description	Pre-Lesson Preparation	Typical Applications	Lesson Development
<p>Demonstration and Performance</p> <p>During demonstration and performance the cadets observe the instructor performing the task in a demonstration, and rehearse it under the supervision of the instructor.</p> <p>Demonstration Method</p> <p>A method of instruction where the instructor, by actually performing an operation or doing a job, shows the cadet what to do, how to do it and explains why, where and when it is done.</p> <p>Performance Method</p> <p>A method in which the cadet is required to perform, under controlled conditions, the operations, skill or movement being taught.</p>	<p>The instructor must be skilled in the task.</p> <p>Gather all materials necessary to instruct the lesson.</p> <p>Break the task down into smaller sequential steps.</p> <p>Practice the lesson to ensure that steps are accurate and clear.</p> <p>Prepare a handout outlining the steps, if necessary.</p> <p>Organize the training area so that all cadets can:</p> <ul style="list-style-type: none"> • see the demonstration, and • perform the task. 	<p>Demonstration Method</p> <p>Demonstration can be used to:</p> <ul style="list-style-type: none"> • teach hands-on operations or procedures; • teach troubleshooting; • illustrate principles; • teach operation or functioning of equipment; • set standards of workmanship; • explain a theory or concept; or • teach safety procedures. <p>Performance Method</p> <p>Performance can be used to:</p> <ul style="list-style-type: none"> • teach hands-on operations or procedures; • teach operation or functioning of equipment; • teach team skills; or • teach safety procedures. 	<p>Introduce the lesson by demonstrating what the cadets will be able to do at the end.</p> <p>Explain where the skill can be applied and why it is important.</p> <p>Provide a handout outlining the steps if the process is complex.</p> <p>Explain and demonstrate each step in a sequential manner.</p> <p>Allow cadets maximum time to practice the steps as soon as possible.</p> <p>Positively reinforce everything the cadets do correctly.</p> <p>Supervise the cadets as they practice, providing assistance or re-demonstrations when necessary.</p> <p>Have cadets perform the skill as confirmation.</p> <p>Encourage the cadets to practice beyond class time.</p>

IN-CLASS ACTIVITY

Description	Pre-Lesson Preparation	Typical Applications	Lesson Development
<p>In-class activities encompass a wide variety of activity-based learning opportunities that can be used to reinforce and practice instructional topics or to introduce cadets to new experiences. In-class activities should stimulate interest among cadets and encourage their participation, while maintaining relevance to the performance objectives. Examples of in-class activities include learning stations, videos, brainstorming, debating, and group work.</p>	<p>Create an activity that involves all cadets, which can be conducted within the time allocated.</p> <p>Clearly specify the objective of the activity.</p> <p>Obtain all materials necessary to complete the activity.</p> <p>Write out specific instructions describing what participants are supposed to do.</p> <p>Write out specific directions for conducting the activity.</p> <p>Arrange for assisting staff, if necessary, to help conduct the activity.</p> <p>Prepare handouts for cadets containing background information.</p> <p>Organize the training area into work/learning stations.</p>	<p>An in-class activity can be used for both knowledge and skill lessons to:</p> <ul style="list-style-type: none"> • reinforce instructional objectives; • introduce a subject and generate interest; • present background information; • give direction on procedures; • introduce a demonstration, discussion or performance; • illustrate the application of rules, principles or concepts; • to create interactivity during a lecture; or • to review, clarify or summarize information. 	<p>Introduce the activity to the whole group.</p> <p>Brief participants on what will be expected of them.</p> <p>Stress timings.</p> <p>Ensure all resources are available.</p> <p>Begin the activity.</p> <p>Supervise and assist the groups as required.</p> <p>Conclude the activity.</p> <p>Confirm the TP or lesson.</p> <p>Debrief the cadets.</p>

PRACTICAL ACTIVITY

Description	Pre-Lesson Preparation	Typical Applications	Lesson Development
<p>Practical activities encompass a wide variety of activity-based learning opportunities that can be used to reinforce and practice instructional topics or to introduce cadets to new experiences. Practical activities should stimulate interest among cadets and encourage their participation, while maintaining relevance to the performance objective.</p>	<p>The instructor must be skilled in the task.</p> <p>Gather all materials necessary to instruct the lesson.</p> <p>Organize the training area so that all cadets will have space to perform the task safely.</p> <p>Ensure there is enough time to conduct the complete activity or breakdown the task into smaller stages.</p> <p>Prepare a handout outlining the steps, if necessary.</p> <p>Arrange for assisting staff, if necessary.</p> <p>Divide cadets into small groups.</p>	<p>The objective of the practical activity method is to reinforce and practice instructional topics or to introduce the cadets to new experiences.</p> <p>If it is used to teach new material it must be combined with other methods to ensure cadets have the necessary background information to complete the activity.</p> <p>The practical activity method can be used to:</p> <ul style="list-style-type: none"> • carry out an application; • demonstrate a process; • verify an explanation; • produce a product; • introduce a subject; • teach manipulative operations; • teach procedures; • teach troubleshooting; • illustrate principles; • teach equipment operation; or • teach safety. 	<p>Review background information.</p> <p>Distribute the handout, if necessary.</p> <p>Introduce the activity to the group.</p> <p>Stress safety.</p> <p>Brief the cadets on what they will be expected to do.</p> <p>Brief assisting staff on what they will be expected to do.</p> <p>Begin the activity.</p> <p>Supervise the cadets and provide assistance, if necessary.</p> <p>Watch for safety infractions and stop the activity, if necessary.</p> <p>Conclude the activity.</p> <p>Debrief the cadets.</p>

GAME

Description	Pre-Lesson Preparation	Typical Applications	Lesson Development
<p>Games are used with one or more participants to practice skills, apply strategies and enhance teams. It is critical that the game supports learning through a challenging activity that allows for skill practice or knowledge confirmation.</p>	<p>Develop a simple game with the following characteristics:</p> <ul style="list-style-type: none"> • fast to play, • easy and quick to organize, • has few rules, • uses minimal equipment, and • involves maximum participation. <p>If possible use variations of games cadets know from childhood or television.</p> <p>Determine the following when developing the rules of the game:</p> <ul style="list-style-type: none"> • individual or team play, • how to change leaders, • what the leader will do, • what the followers will do, • timings for the game, • how to signal the start and stop of the game, • how to ensure safety. <p>Obtain the resources needed to play the game.</p> <p>Organize the training area to play the game.</p>	<p>Games create variety and arouse interest but must also support learning.</p> <p>Games can be used to:</p> <ul style="list-style-type: none"> • introduce a topic; • discover concepts and principles; • learn terminology; • recall terms; • recognize equipment parts; • develop strategies and tactics; • carry out an application; • demonstrate a process; • practice interpersonal skills; and/or • confirm learning 	<p>Brief the cadets on the following:</p> <ul style="list-style-type: none"> • the objective of the game, and • rules of the game. <p>Play the game.</p> <ul style="list-style-type: none"> • Supervise closely to : • ensure that the game is played in the manner expected; • ensure that the game is played safely; and • ensure maximum participation. <p>End the game.</p> <p>Debrief the cadets.</p>

FIELD TRIP

Description	Pre-Lesson Preparation	Typical Applications	Lesson Development
<p>Theoretical knowledge is reinforced through participation in an activity in a real-life setting. Prior planning helps to ensure all pre-training and safety standards are met. Field trip activities are planned and carried out to achieve clear instructional objectives that are understood by the cadets. Examples include trips to areas of local interest, flying/gliding, hiking and/or sailing.</p>	<p>Specify the objective(s) of the field trip.</p> <p>Determine the time and location of the field trip.</p> <p>Obtain necessary authorizations.</p> <p>Determine the timings.</p> <p>Determine the activities or demonstrations needed to achieve the objectives.</p> <p>Determine if trained personnel will be available to assist.</p> <p>Arrange the following, if necessary:</p> <ul style="list-style-type: none"> • transportation, • supervision, and • meals. <p>Determine if the cadets will be allowed to use equipment or participate in a training activity.</p> <p>Determine if all cadets can take part at once or if they need to be rotated through.</p> <p>Divide the cadets into groups, if necessary.</p> <p>Ensure safety.</p>	<p>The field trip is used to:</p> <ul style="list-style-type: none"> • introduce/illustrate and confirm topics; • reinforce and clarify classroom learning; • inject variety into the training situation; or • allow cadets to view operations or equipment that cannot easily be shown in the classroom. 	<p>Inform cadets as soon as possible of the following:</p> <ul style="list-style-type: none"> • time of the field trip, • location of the field trip, and • timings for departure. <p>Brief cadets on the following prior to departure:</p> <ul style="list-style-type: none"> • objectives of the field trip, • timings and groupings for activities and demonstrations, and • how they will participate during the field trip. <p>During the field trip ensure the following:</p> <ul style="list-style-type: none"> • the safety of all cadets, • maximum participation, and • the objectives are met. <p>After the field trip:</p> <ul style="list-style-type: none"> • debrief the cadets; and • confirm that objectives have been met. <p>Express appreciation to the facilitators of the field trip.</p>

SELECT A METHOD OF INSTRUCTION

Lesson Topic	Method of Instruction	Explanation
Participate in a Discussion on Hygienic Practices During Physical Activity		
Identify the Parts and the Characteristics of the Daisy 853C Air Rifle		
Apply Basic Marksmanship Techniques		
Participate in a Discussion on Proficiency Level One Training		
Wear the Air Cadet Uniform		
Participate in a Discussion of Year One Summer Training Opportunities		
Construct a Lean-to-Style Shelter		
Operate a Hand Held Radio		
Invent a Space Technology Item		
Discuss Aircraft Flown in WWI and WWII		
Discuss Leadership Within a Peer Setting		
Identify Year Two CSTC Training Opportunities		
Fly a Paper Colditz Glider		
Explain Aspects of Air Traffic Control		
Identify the Rank Structure of the Royal Canadian Sea, Army and Air Cadets		

THIS PAGE INTENTIONALLY LEFT BLANK

POSING QUESTIONS SEQUENCE

Question Sequence	Action
Pose the question	The instructor must ensure that they have the full attention of the class and ask a question that is clearly heard by all.
Pause	The instructor must allow cadets time to think of a response. Do not waste time, but avoid answering the question for the cadets just to break the silence.
Pounce	When using a direct question the instructor must indicate which cadet will answer.
Ponder	The instructor must allow the cadets time to answer fully, listen carefully to the response, confirm the correct response and explain why it is correct. If an answer is incomplete, the instructor must emphasize what is correct and ask a follow-up question to complete the response or simply provide additional information. If an answer is incorrect the instructor must point that out as well, in a manner that does not embarrass the cadet and explain why the answer is incorrect. There may be a need to reword the question to get a better response.
Praise	The instructor must praise all cadets for participating and confirm/ summarize all correct responses so as to avoid confusion regarding which responses were correct or incorrect.

THIS PAGE INTENTIONALLY LEFT BLANK

QUESTIONS HANDOUT

Read the short passage to the group and ask them to remember the children's story "Goldilocks and the Three Bears."

Once upon a time there was a little girl named Goldilocks. She went for a walk in the forest. Pretty soon, she came upon a house. She knocked and, when no one answered, she walked right in.

Use the questions below to have each cadet use the question posing sequence at least once.

Q. Who do you think lived in the house in the forest?

A. The three bears.

Q. What did Goldilocks first do when she entered the house?

A. She tasted the porridge.

Q. Whose chair did Goldilocks break?

A. Little bear's chair.

Q. Why did Goldilocks go upstairs to the bedroom?

A. She felt tired.

Q. Did Goldilocks ever return to the house in the forest?

A. No.

THIS PAGE INTENTIONALLY LEFT BLANK

POSING QUESTIONS RUBRIC

STANDARD

Effective Questioner: Follows posing questions sequence when asking questions.

PERFORMANCE TASK

Ask a recall question to the group about the children’s story, “Goldilocks and the Three Bears” using the posing questions sequence.

Performance Element	Met the Standard (Level 3)	Met the Standard With Difficulty (Level 2)	Did Not Meet the Standard (Level 1)
Pose the question	Had the attention of the group. Asked the question clearly.	Had the attention of the group. Did not ask the question clearly.	Did not get the attention of the group. Did not ask the question carefully.
Pause	Allowed cadets ample time to think of a response. Did not waste time. Did not answer the question for the cadets.	Unsure of how much time to allow for a response.	Allowed too much/too little time for a response. Answered the question for the cadet.
Pounce	Pointed to a cadet.	Had to be told to point to a cadet.	Allowed anyone to answer.
Ponder	Allowed cadet to answer fully. Confirmed correct response. Explained incorrect answer.	Allowed cadet to answer fully. Confirmed correct response after being prompted. Explained incorrect response after being prompted.	Did not allow cadet to answer fully. Did not confirm correct response after being prompted. Did not explain incorrect response after being prompted.
Praise	Ensured all cadets participated. Praised correct response appropriately. Clarified any confusion regarding responses.	Ensured all cadets participated. Had to be prompted to praise correct response. Had to be prompted to clarify confusion regarding responses.	Did not ensure all cadets participated. Failed to praise correct responses. Did not clarify lingering confusion regarding responses.

THIS PAGE INTENTIONALLY LEFT BLANK

POSING QUESTIONS CHECKLIST

Place a check mark in the appropriate box.

Name	Pose the Question			Pause			Pounce			Ponder			Praise		
	Level 1	Level 2	Level 3	Level 1	Level 2	Level 3	Level 1	Level 2	Level 3	Level 1	Level 2	Level 3	Level 1	Level 2	Level 3

THIS PAGE INTENTIONALLY LEFT BLANK

COMMON INSTRUCTIONAL AIDS

INSTRUCTIONAL AIDS

HOW INSTRUCTIONAL AIDS WORK

During the communication process, the brain filters the important pieces of information from the less significant pieces. What is considered to be the most important information is passed to the short-term memory for possible storage into the long-term memory. Instructional aids support learning by highlighting and emphasizing the most important pieces of information for the brain to store in memory.

Instructional aids also:

- attract and hold the cadets' attention;
- involve the two most important senses – sight and sound; and
- help instructors teach more in less time.

CHARACTERISTICS OF INSTRUCTIONAL AIDS

Instructional aids should:

- support the lesson by emphasizing and clarifying important information;
- keep the cadets' attention on the topic;
- contain quality pictures, graphs or text;
- be simple and easy to use; and
- be large enough to be seen and loud enough to be heard.

GUIDELINES FOR USING INSTRUCTIONAL AIDS

During the lesson planning stage the following process can be used to determine if and where instructional aids are necessary:

- clearly establish the lesson objective – the information to be communicated or the task to be accomplished;
- research supporting material to achieve the lesson objective;
- organize the material into a lesson plan; and
- select the important points to be supported by instructional aids.



Instructional aids should be used only if they support learning and should not be made visible until the appropriate time during a lesson so as not to become a distraction.

VERBAL SUPPORT

Almost all ideas need some sort of clarification, explanation or proof to be understood. If cadets are learning something new, they want proof to support what is being said. The lesson topic, the instructional method, the cadets' background knowledge and the size of the group are factors that determine how much learning support is required.

Verbal support is one type of support instructors use to clarify, prove, illustrate, emphasize or to add variety and interest to information during a lesson. Types of verbal support include:

- **COMPARISONS**

A comparison is a bridge built by the instructor between the known and the unknown. New information can be clarified by pointing out its similarity to a familiar topic, idea or situation. A factual comparison clarifies by highlighting how two or more related things are similar. For example, a factual comparison is used when the **similarities** between two or more different types of uniforms are highlighted. A contrast clarifies by highlighting how two or more things are different. A contrast is used when the **differences** between two or more types of uniforms are highlighted. Figurative comparisons use similes and metaphors to add variety and gain attention. A figurative comparison is used when expressions such as the “ship cut through the water like a knife” or “the ship knifed through the water” are used to indicate the ship's speed.

- **REASONS**

Reasons are logical explanations that satisfy the question “why”. Explaining the reason for something often makes it easier for the cadets to accept what is being explained. When instructors cite “safety concerns” as the reason why a task must be completed a certain way, they are using reasons as verbal support.

- **RESTATEMENT AND REPETITION**

Instructors can emphasize main ideas or key points by repeating them. One way to repeat something is to restate it in a different way. Skillful repetition can also persuasively help cadets accept an idea or point of view. Sometimes directions or instructions need to be repeated many times without change for clarity.

- **EXAMPLES**

An example is a specific instance of a general idea used to clarify or simplify information. It should be short and specific and in the cadets' background knowledge so that the cadets can associate new information with something already known.

- **STATISTICS**

Statistics are a summary of numerical information about an event or thing. If properly used, statistics help instructors prove or emphasize main points and create interest in the information. Do not assume, however, that verbal support is being used every time a number or figure is quoted. For example, saying “last year's national budget for cadets was approximately \$180 million” is a statement of fact but saying “last year's cadet budget was approximately \$3 000.00 for every cadet in Canada” is using statistics to emphasize the point that the cadet budget is large.

- **TESTIMONY**

Testimony is simply using the experiences, words and thoughts of others to emphasize or prove points. Testimonials are believable because they are offered by experts or people with first-hand knowledge. For example, simply saying, “the cadet organization offers many advantages to youth” is not as powerful as quoting or hearing from cadets who have gone through the program and realized its benefits.



The acronym **CRREST** can be used to remember the different types of verbal support.

AUDIOVISUAL AIDS

Instructional aids appeal to all five senses. Audiovisual aids are particularly effective because individuals learn and retain over 50 percent of what they both see and hear.

MODELS

A model is a copy of a real object and can be an enlargement, a reduction or the same size as the original. Two types of models are:

- the scale model which is an exact reproduction of the original, and
- the simplified model, which does not represent reality in all details.

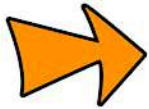

As instructional aids, models are usually more practical than the real object because they are lightweight and easy to manipulate.

Mock-Ups

A mock-up is a three dimensional or specialized type of working model and is used for study, training or testing in place of the real object, which may be too costly, too dangerous or impossible to obtain. The advantage of the mock-up over the real thing is that the mock-up may emphasize the essential elements to be learned by distinguishing them from non-essential elements.

Cut-Aways

Some models are solid and show only the outline of the object while others can be manipulated or operated. Specialized models, called cut-aways, are built in sections and can be taken apart to reveal an internal structure. Whenever possible, the various parts should be labelled and coloured to clarify relationships.



Production and equipment costs are limiting factors in developing and using models, mock-ups and cut-aways. If a two-dimensional representation will satisfy the instructor's needs it should be used.

THE REAL OBJECT AND REALISTIC IMAGES

The real object is often the most effective visual aid. To be effectively used the real object should be safe and big enough for everyone to see or small enough and available enough for each cadet to have one. Realistic images, including quality photographs or drawings of the real object, are suitable replacements if the real object cannot be obtained or effectively used.



Realistic images and objects are most effective when they are used after a teaching point has been introduced.

GRAPHICS

Graphics, which include charts, graphs, maps, diagrams, drawings and cartoons, can be used to clarify relationships between concepts or effectively explain a concept that would otherwise require a lengthy description.

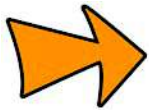

Graphics catch the cadets' attention and stimulate thinking by:

- presenting one idea;
- avoiding too many details; and
- using colours, which contrast with the background to emphasize main points.

PROJECTED MATERIAL

Projected material includes videotapes, DVDs and slides projected by an overhead projector or computer. Short, high-quality video presentations have become one of the most popular instructional aids.

Passive video, which includes VHS, DVDs and slides, provides motion, colour, sound and in some cases special advanced graphic and animation techniques. The availability, low cost and user-friendly characteristics are important advantages of passive video but instructors should be aware it is often difficult for instructional video to compete with the action-packed entertainment videos and is often considered less exciting and stimulating by cadets. This, in addition to the cadets' often passive viewing style for entertainment videos, can diminish the instructional value of the video.

To increase the value of passive video for instructional purposes, instructors should follow these basic guidelines:

- preview the video to determine the important points and concepts;
- prepare the cadets for viewing the video by stressing what is important to watch; and
- summarize the presentation and answer any questions the cadets may have.



Video presentations are not designed to replace the instructor.

Videotapes and DVDs are generally purchased but slides can easily be developed by hand or by using a computer.

Guidelines for developing slides are:

- illustrate key points;
- use key words or phrases as headers for each slide;
- include a maximum of six words per line and six lines per slide; and
- use lettering large enough to be clearly read from the back of the classroom.



Use of projected materials requires planning and practice. Instructors should set up and adjust the equipment and lighting beforehand and always preview the presentation.

Interactive video refers to software that responds to choices and commands by the user. A typical system consists of a combination of a compact disk and computer with video presentation capability. The software may include image banks of colour photos and graphics as well as questions or directions, which are programmed to create interactivity for students as they progress through the course.



Interactive video solves one of the main problems of passive video in that it increases the cadets' involvement in the learning process. Each cadet receives a customized learning experience.

SIMULATORS

Simulators are mechanical or electronic devices that act like the actual equipment or systems and provide the cadets with realistic practice in a safe and controlled environment. They may have various capabilities such as jump, freeze, record and replay which can capture and playback information for instructional feedback. Simulators replicate the real thing at a fraction of the cost.

Some concerns include:

- the need for the provision of background information,
- the requirement for hardware and software maintenance,
- the need for expertise to run the simulator, and
- the need for specialized facilities.

Some of the more commonly recognized simulators include flight simulators, driver training simulators and marine simulators, which simulate normal and emergency situations, which would otherwise be encountered in real life.

TRAINING EQUIPMENT

Training equipment refers to the use of actual equipment such as boats, air rifles, or gliders for training purposes. The main advantage of this type of aid is that it is the actual piece of equipment or system that the cadet will be expected to use. Despite the benefits of simulators, training is not complete without intensive training in or with the real thing.

Some concerns include:

- the need for subject matter experts,
- the high maintenance costs,
- the need for modifications for instructional purposes, and
- scheduling difficulties caused by external factors such as weather and the availability of the resources.

In short, cadets will only learn to sail, fly or complete an expedition by using a sailboat or glider or travelling to the field.

SELECT AN INSTRUCTIONAL AID

GUIDELINES FOR SELECTING INSTRUCTIONAL AIDS

During the lesson planning stage the following process can be used to determine if and where instructional aids are necessary:

- clearly establish the lesson objective – the information to be communicated or the task to be accomplished;
- research supporting material to achieve the lesson objective;
- organize the material into a lesson plan; and
- select the important points to be supported by instructional aids. Instructional aids are appropriate when:
 - long segments of technical description are necessary;
 - a point is complex and difficult to put into words;
 - instructors find themselves forming visual images; and
 - students are puzzled by an explanation or description.

The selection of instructional aids depends on several factors, which include:

- **Availability.** Which ready-made aids are available? What resources are available to make instructional aids?
- **Facilities.** Does the training area or equipment available allow the instructor to use certain instructional aids?
- **Cost.** Are the instructional aids too expensive to purchase or produce?
- **Class size.** Does the number of people in the class make the use of the instructional aid practical? Does the instructional aid encourage cadet participation?

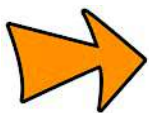

Instructional aids should be used only if they support learning and should not be a distraction.

INSTRUCTIONAL AID WORKSHEETS

INSTRUCTIONAL AIDS Worksheet

1. How do instructional aids support learning?

2. In your opinion, what is the most important characteristic of instructional aids?

3. When should instructional aids be used during a lesson?

VERBAL SUPPORT Worksheet

Match Column A with Column B by placing the correct number from Column B opposite the correct phrase from Column A.

Column A

- a. a bridge between the known and unknown
- b. numerical information about an event or thing
- c. can be used to persuade the cadets to accept an idea
- d. a specific instance of a general idea
- e. logical explanations that satisfy the question "why"
- f. using the words of others to prove a point
- g. highlighting how two or more things are different

Column B

- 1. testimony
- 2. reasons
- 3. comparison
- 4. statistics
- 5. repetition
- 6. example
- 7. contrast

AUDIOVISUAL AIDS

Worksheet

COMPLETE THE CROSSWORD PUZZLE

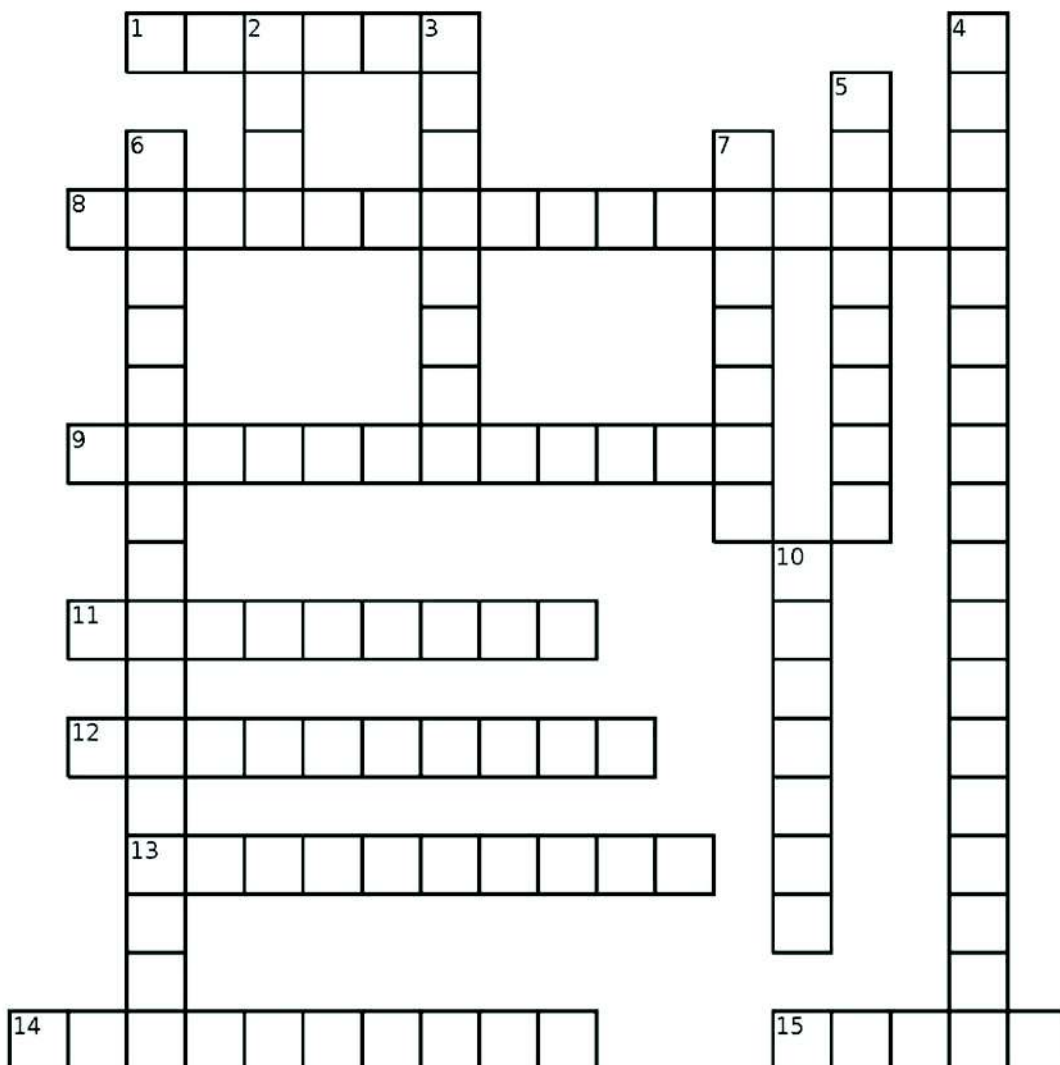

CROSSWORD PUZZLE CLUES

Across

1. a specialized type of working model (2 words)
8. appeals to all five senses (2 words)
9. video, which lacks cadet involvement (2 words)
11. one type of projected material (2 words)
12. the most effective visual aid (2 words)
13. video presentations should not replace the ...
14. an example of a realistic image
15. copy of the real object

Down

2. a limiting factor in developing models
3. use of projected material requires planning and ...
4. instructional aids are most effective when they are ... (5 words)
5. can effectively replace a lengthy explanation
6. software that responds quickly to commands (2 words)
7. an example of a graphic instructional aid
10. a model that can be taken apart (2 words)

ANSWER KEY

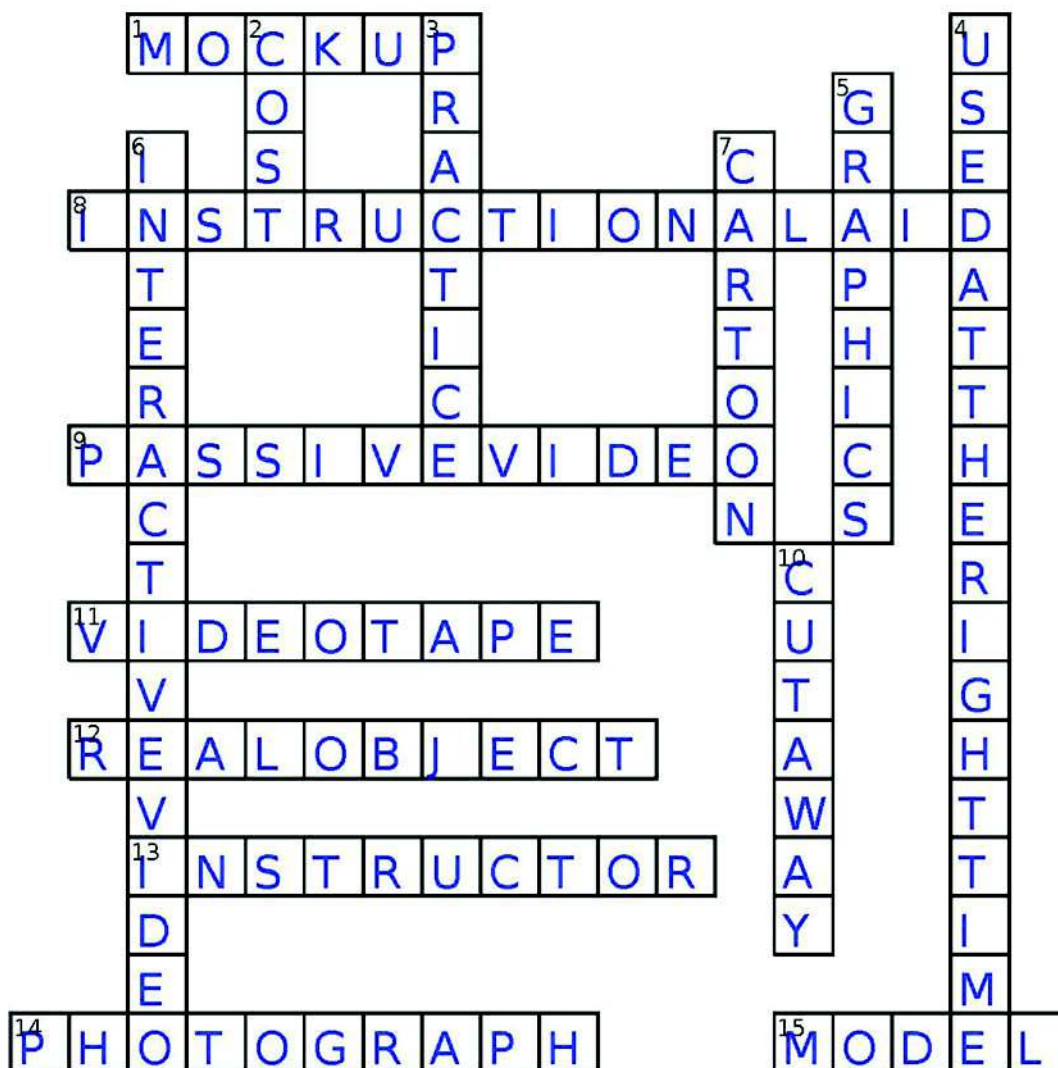

SIMULATORS AND TRAINING EQUIPMENT

Worksheet

1. What do simulators provide the cadets?

2. List four concerns about simulators.

3. What is the main advantage of training equipment as an instructional aid?

4. List four concerns about training equipment.

SELECT AN INSTRUCTIONAL AID Worksheet

Using the "Select an Instructional Aid" information sheet, select an instructional aid you would consider appropriate for each of the topics listed below.

Lesson Topic	Type of Instructional Aid
Participate in a Discussion on Hygienic Practices During Physical Activity	
Identify the Parts and the Characteristics of the Daisy 853C Air Rifle	
Apply Basic Marksmanship Techniques	
Participate in a Discussion on Phase One Training	
Wear the Air Cadet Uniform	
Participate in a Discussion of Year One Summer Training Opportunities	
Construct a Lean-to-Style Shelter	
Operate a Hand Held Radio	
Invent a Space Technology Item	
Discuss Aircraft Flown in WWI and WWII	
Discuss Leadership Within a Peer Setting	
Identify Year Two CSTC Training Opportunities	
Fly a Paper Colditz Glider	
Explain Aspects of Air Traffic Control	
Identify the Rank Structure of the Royal Canadian Sea, Army and Air Cadets	

THIS PAGE INTENTIONALLY LEFT BLANK

LESSON SPECIFICATION AND INSTRUCTIONAL GUIDE HANDOUT

ENABLING OBJECTIVE AND LESSON SPECIFICATION

Performance objectives are broken down into a series of enabling objectives and lesson specifications. The enabling objective consists of Paragraphs 1. to 3. (as illustrated in Figure 9K-1). The information in these paragraphs will answer three questions:

1. What will the cadet be expected to be able to do by the end of this lesson?
2. Under what conditions will the cadet be expected to carry out the performance?
3. How well or to what standard will the cadet be expected to perform?

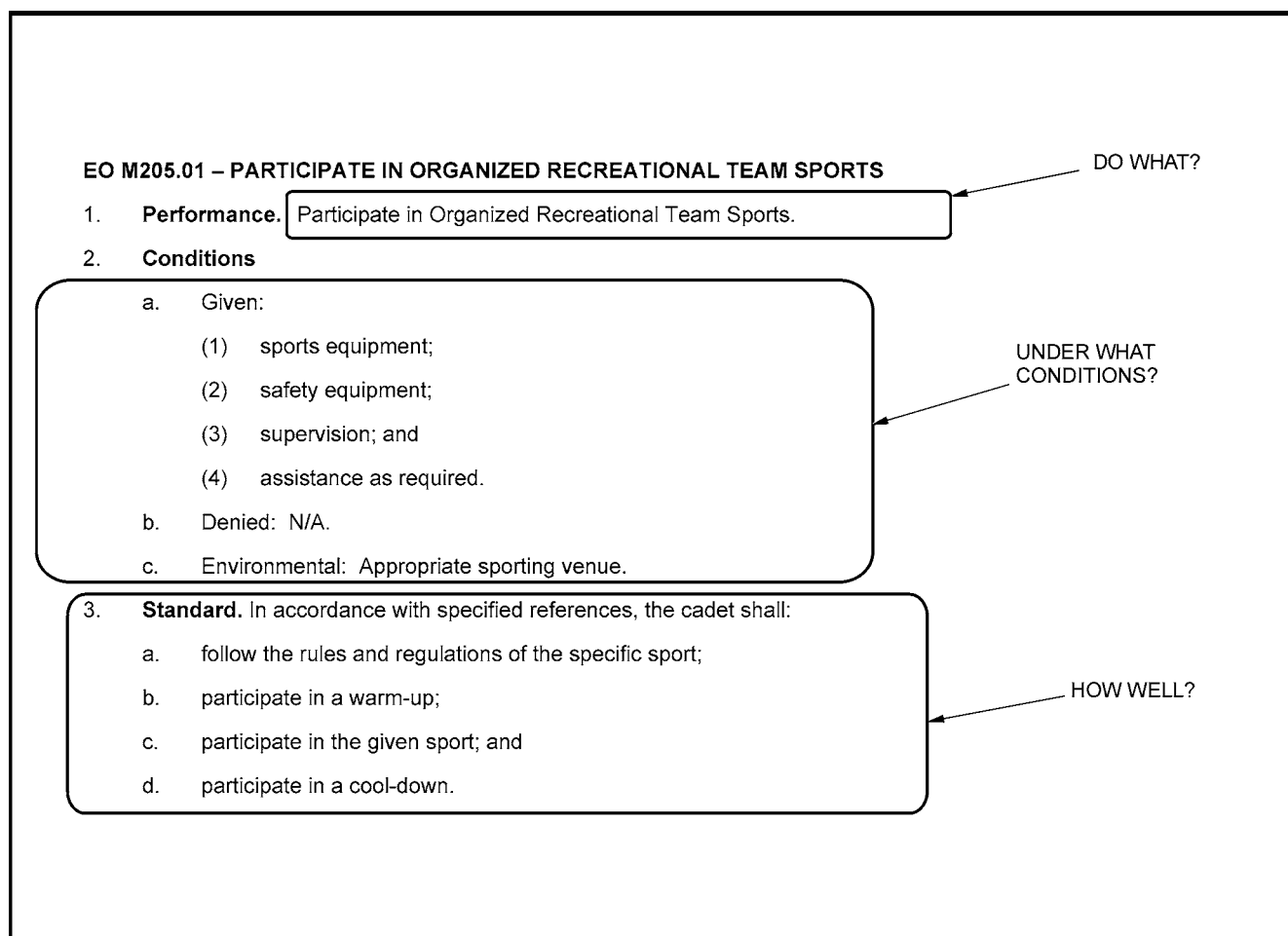

Director Cadets 3, 2008, Ottawa, ON: Department of National Defence

Figure 9K-1 Enabling Objective

Paragraphs 4. to 11. are known as the lesson specification. The lesson specification provides information about the content to be taught, teaching methods, time, references, training aids, learning aids, test details and remarks.

In Paragraph 4., the TPs are usually described in a table where information is provided on the content taught in each TP, the suggested teaching method, the time for each TP and references (as illustrated in Figure 9K-2).

4. Teaching Points

TP	Description	Method	Time	Ref
TP1	Introduce cadets to a specific sport's rules and regulations, to include: <ul style="list-style-type: none"> a. an overview of how to play the sport; and b. rules and regulations of the sport. 	Interactive Lecture	10 min	C0-001
TP2	Conduct a warm-up session, composed of light cardiovascular exercises, meant to: <ul style="list-style-type: none"> a. stretch the muscles; b. gradually increase respiratory action and heart rate; c. expand the muscles' capillaries to accommodate the increase in blood circulation; and d. raise muscle temperature to facilitate reactions in muscle tissue. 	Practical Activity	10 min	C0-002 (pp. 109 to 113) C0-089
TP3	Supervise the cadets' participation in a given sports activity.	Practical Activity	50 min	

Director Cadets 3, 2008, Ottawa, ON: Department of National Defence

Figure 9K-2 Teaching Points

Paragraph 5. outlines how much time is spent on the introduction/conclusion and the different teaching methods. Paragraph 6. offers substantiation or reasons why certain teaching methods were recommended for each TP. Paragraph 7. provides a list of references used to compile the content in Paragraph 4. (as illustrated in Figure 9K-3).

<p>5. Time</p> <p>a. Introduction/Conclusion: 10 min</p> <p>b. Interactive Lecture: 10 min</p> <p>c. Practical Activity: 70 min</p> <p>d. Subtotal: 90 min</p> <p>e. Total (three sessions): 270 min</p> <p>6. Substantiation</p> <p>a. An interactive lecture was chosen for TP1 to illustrate the application of rules, principles, or concepts of the specific sport to be played.</p> <p>b. A practical activity was chosen for TP2–4 as it allows cadets to participate in sports activities in a safe and controlled environment. This activity contributes to the development of sports skills in a fun and challenging setting.</p> <p>7. References</p> <p>a. C0-001 (ISBN 0-88011-807-5) Hanlon, T. (1998). <i>The Sports Rules Book: Essential Rules for 54 Sports</i>. USA: Human Kinetics Publishers, Inc.</p> <p>b. C0-002 (ISBN 0-88962-630-8) LeBlanc, J., and Dickson, L. (1997). <i>Straight Talk About Children and Sport: Advice for Parents, Coaches, And teachers</i>. Oakville, ON and Buffalo, NY: Mosaic Press.</p>

Director Cadets 3, 2008, Ottawa, ON: Department of National Defence

Figure 9K-3 Paragraphs 5–7

Paragraphs 8. and 9. list the training aids and learning aids required for the lesson. Training aids are the materials that are required by the instructor to instruct the lesson and learning aids are the materials that will be required by the cadet to participate in the lesson (as illustrated in Figure 9K-4).

<p>8. Training Aids</p> <p>a. Sports/safety equipment appropriate for the activity;</p> <p>b. First aid kit;</p> <p>c. Whistles; and</p> <p>d. Stopwatch.</p> <p>9. Learning Aids. Sports equipment.</p>
--

Director Cadets 3, 2008, Ottawa, ON: Department of National Defence

Figure 9K-4 Training Aids and Learning Aids

Paragraph 10. is test details, which is information about the evaluation to be conducted. Paragraph 11. is remarks, which describe any other information that may be useful to the Training Officer or instructor (as illustrated in Figure 9K-5).

10. **Test Details.** N/A.
11. **Remarks**
 - a. The CCO list of approved sports is located at A-CR-CCP-802/PF-001, Annex A.
 - b. Recreational sports can be carried out as nine periods during a supported day or over three sessions of three periods each.

Director Cadets 3, 2008, Ottawa, ON: Department of National Defence

Figure 9K-5 Test Details and Remarks

INSTRUCTIONAL GUIDE

The IG is used in conjunction with the QSP and other resources to conduct training. IGs should be reviewed in conjunction with lesson specifications so that the instructor can adequately plan and prepare their lesson. IGs do not replace lesson plans but offer written content, supporting figures and suggestions on how to instruct a lesson. The following are the six sections of an IG:

1. preparation,
2. introduction,
3. body,
4. conclusion,
5. references, and
6. annexes.

Preparation

The preparation section provides information about where to find the lesson specification and any instructions to the instructor such as reviewing lesson content, photocopying handouts, pre-lesson assignments and the approach and substantiation as to why certain teaching methods were recommended for each TP.

Introduction

The introduction section provides information to the instructor about review that may be necessary, what the cadet will be expected to do by the end of the lesson and why the knowledge/skills are important.

The Body

The body of the IG contains all of the TPs and content listed in Paragraph 4. of the lesson specification in greater detail. The body provides suggested teaching methods, note boxes with special instructions or information (as illustrated in Figure 9K-6), lesson content, figures, activities and confirmation questions.

Note Boxes:



Special note to the instructor.



Key information to pass along to the cadets.



Refer to the following CF regulations and policies.



Points of interest or special instructions should pass along to the cadets.

Director Cadets 3, 2008, Ottawa, ON: Department of National Defence

Figure 9K-6 Note Boxes

The Conclusion

The conclusion section states any homework/reading/practice that may be required of the cadet and the method of evaluation as stated in the lesson specification. The conclusion section also provides a closing statement to be spoken aloud to the cadets and any additional instructor notes/remarks.

References

The reference section lists the references used to create the lesson specification and instructional guide. In some cases, an IG may direct the instructor to a specific reference to be used during a lesson. In most cases this section is only used to identify where the content of the lesson has been drawn from.

Annexes

The annex section contains information that may range from pre-made training aids, learning aids such as handouts and additional information for activities.

THIS PAGE INTENTIONALLY LEFT BLANK

LESSON PLAN

EO #:		Title of the EO:
Instructor:		Location: Total Time: min
TIME	REVIEW	NOTES
	EO#: ENABLING OBJECTIVE:	
TIME	INTRODUCTION	NOTES
	What: Where: Why:	
TIME	BODY	NOTES
	Teaching Method: TP 1: TP 1 Confirmation:	

PLAN A LESSON CHECKLIST

PREPARATION	NOTES
<p>Have you:</p> <ul style="list-style-type: none"> <input type="checkbox"/> Selected an appropriate lesson location? <input type="checkbox"/> Selected an appropriate method of instruction? <input type="checkbox"/> Provided for a review of previous lesson materials? 	
INTRODUCTION	
<p>Does your introduction:</p> <ul style="list-style-type: none"> <input type="checkbox"/> State what the cadets will learn? <input type="checkbox"/> Describe why the information is important to learn? <input type="checkbox"/> Describe where and when the information / skill can be used? 	
BODY	
<p>Does the body of your lesson:</p> <ul style="list-style-type: none"> <input type="checkbox"/> Include the different principles of instruction? <input type="checkbox"/> Include questions? <input type="checkbox"/> Provide for the use of instructional aids? <input type="checkbox"/> Used explanation and demonstration? (skill lesson only) <input type="checkbox"/> Confirm each TP? 	
END OF LESSON CONFIRMATION	
<ul style="list-style-type: none"> <input type="checkbox"/> Did you conduct an end of lesson confirmation by using questions or by conducting an activity? 	
CONCLUSION	
<p>Does your conclusion:</p> <ul style="list-style-type: none"> <input type="checkbox"/> Summarize the lesson? <input type="checkbox"/> Re-motivate the cadets by: <ul style="list-style-type: none"> <input type="checkbox"/> commenting on their progress; and <input type="checkbox"/> re-stating why the information learned is important? <input type="checkbox"/> Describe the next lesson? 	

THIS PAGE INTENTIONALLY LEFT BLANK

LIST OF APPROVED 15-MINUTE TOPICS

TP 1 of M104.01 (Identify Activities That Will Help Achieve a Healthy Active Lifestyle, A-CR-CCP-801/PG-001, Chapter 4, Section 4 and A-CR-CCP-801/PF-001, Chapter 4, Section 1)

TP 1 of M106.01 (Identify the Parts and the Characteristics of the Daisy 853C Air Rifle, A-CR-CCP-801/PG-001, Chapter 4, Section 6 and A-CR-CCP-801/PF-001, Chapter 6, Section 1)

TP 4 of M106.03 (Apply Basic Marksmanship Techniques, A-CR-CCP-801/PG-001, Chapter 4, Section 6 and A-CR-CCP-801/PF-001, Chapter 6, Section 3)

TP 1 of M203.01 (Discuss Leadership Within a Peer Setting, A-CR-CCP-802/PG-001, Chapter 4, Section 3 and A-CR-CCP-802/PF-001, Chapter 3, Section 1)

TPs 1 and 2 of M129.01 (Recite the Phonetic Alphabet, A-CR-CCP-801/PG-001, Chapter 4, Section 11 and A-CR-CCP-801/PF-001, Chapter 11)

TP 3 of M129.01 (Recite the Phonetic Alphabet, A-CR-CCP-801/PG-001, Chapter 4, Section 11 and A-CR-CCP-801/PF-001, Chapter 11)

TP 1 of M130.02 (Describe the Main Components of an Aircraft, A-CR-CCP-801/PG-001, Chapter 4, Section 12 and A-CR-CCP-801/PF-001, Chapter 12, Section 2)

TP 1 of M160.01 (Identify Major Aerodrome Components, A-CR-CCP-801/PG-001, Chapter 4, Section 14 and A-CR-CCP-801/PF-001, Chapter 14, Section 1)

TPs 1 and 2 of M160.02 (Identify Features of a Runway, A-CR-CCP-801/PG-001, Chapter 4, Section 14 and A-CR-CCP-801/PF-001, Chapter 14, Section 2)

TPs 4 and 5 of M230.01 (Discuss Aircraft Flown During WWII, A-CR-CCP-802/PG-001, Chapter 4, Section 10 and A-CR-CCP-802/PF-001, Chapter 10, Section 1)

TP 3 of M231.02 (Describe the Production of Lift by an Aircraft Wing, A-CR-CCP-802/PG-001, Chapter 4, Section 11 and A-CR-CCP-802/PF-001, Chapter 11, Section 2)

TPs 1 and 2 of M231.04 (Describe the Axial Movements of an Aircraft, A-CR-CCP-802/PG-001, Chapter 4, Section 11 and A-CR-CCP-802/PF-001, Chapter 11, Section 4)

TP 1 of M232.01 (Identify Types of Aircraft Engines, A-CR-CCP-802/PG-001, Chapter 4, Section 12 and A-CR-CCP-802/PF-001, Chapter 12, Section 1)

TP 2 of C232.03 (Identify the Characteristics of Helicopter Engines, A-CR-CCP-802/PG-001, Chapter 4, Section 12 and A-CR-CCP-802/PF-001, Chapter 12, Section 7)

TP 2 of C240.03 (Identify Parts of a Rocket, A-CR-CCP-802/PG-001, Chapter 4, Section 13 and A-CR-CCP-802/PF-001, Chapter 13, Section 6)

Note: The TPs in this list were selected because they best fit into the 15-minute format. The selected EOs are a variety of knowledge and skill-based lessons.

THIS PAGE INTENTIONALLY LEFT BLANK

MODIFIED LESSON INSTRUCTIONS AND INSTRUCTIONAL GUIDES – TP 1 OF EO M104.01

A-CR-CCP-801/PG-001

EO M104.01 – IDENTIFY ACTIVITIES THAT WILL HELP ACHIEVE A HEALTHY ACTIVE LIFESTYLE

1. **Performance.** Identify Activities That Will Help Achieve a Healthy Active Lifestyle.
2. **Conditions**
 - a. Given:
 - (1) a copy of *Canada's Physical Activity Guide to Healthy Active Living*;
 - (2) supervision; and
 - (3) assistance as required.
 - b. Denied: N/A.
 - c. Environmental: Suitable classroom facilities/training area large enough to accommodate entire group.
3. **Standard.** In accordance with *Canada's Physical Activity Guide to Healthy Active Living*, the cadet shall identify activities that will help achieve a healthy and active lifestyle.

4. **Teaching Points**

TP	Description	Method	Time	Ref
TP1	Introduce cadets to <i>Canada's Physical Activity Guide to Healthy Active Living</i> , to include: <ol style="list-style-type: none"> a. page 4 – Check Out What You Are Doing Now; b. page 5 – Benefits of Physical Activity; c. page 6 – What Are You Into; d. page 8 – Let's Get Active; and e. page 10 – Crank Up Your Activity. 	Interactive Lecture	10 min	C0-020 (pp. 4 to 10)

5. **Time**
 - a. Introduction/Conclusion: 5 min
 - b. Interactive Lecture: 10 min
 - c. Total: 15 min
6. **Substantiation.** For TP1, the interactive lecture method was chosen as it allows the instructor to make a semi-formal presentation of the material where the cadets can participate by asking or responding to questions and commenting on the material. For this lesson, this method is most effective as it matches well the taxonomic level of the material and is age-appropriate by virtue of its participatory nature.
7. **References.** C0-020 (ISBN 0-662-32899) Minister of Health. (2002). *Canada's Physical Activity Guide to Healthy Active Living* [Brochure].
8. **Training Aids**
 - a. Presentation aids (i.e. whiteboard/flipchart/OHP) appropriate for classroom/training area; and
 - b. *Canada's Physical Activity Guide to Healthy Active Living*.

9. **Learning Aids.** *Canada's Physical Activity Guide to Healthy Active Living.*
10. **Test Details.** N/A.
11. **Remarks.** N/A.

A-CR-CCP-801/PF-001



**COMMON TRAINING
PROFICIENCY LEVEL ONE
INSTRUCTIONAL GUIDE**



SECTION 1

EO M104.01 – IDENTIFY ACTIVITIES THAT WILL HELP ACHIEVE A HEALTHY ACTIVE LIFESTYLE

Total Time: 15 min

PREPARATION

PRE-LESSON INSTRUCTIONS

A complete list of resources needed for the instruction of this EO is located at Chapter 4 of the QSP. Specific uses for said stores are identified throughout the Instructional Guide, within the teaching point for which they are required.

The instructor shall review the lesson content and become familiar with the material prior to the instruction of the lesson.

PRE-LESSON ASSIGNMENT

N/A.

APPROACH

For TP1, the interactive lecture method was chosen as it allows the instructor to make a semi-formal presentation of the material where the cadets can participate by asking or responding to questions and commenting on the material. For this lesson, this method is most effective as it matches well the taxonomic level of the material and is age-appropriate by virtue of its participatory nature.

INTRODUCTION

REVIEW

N/A.

OBJECTIVES

By the end of this lesson the cadet shall be expected to identify activities that will help them achieve a healthy and active lifestyle.

IMPORTANCE

Physical fitness is one of the three aims of the cadet program. Teaching the cadets what activities contribute to an active lifestyle will help them achieve physical fitness.

A-CR-CCP-801/PF-001

Teaching Point 1

Introduce Cadets to *Canada's Physical Activity Guide to Healthy Active Living*

Time: 10 min

Method: Interactive Lecture

CANADA'S PHYSICAL ACTIVITY GUIDE TO HEALTHY ACTIVE LIVING

Hand out *Canada's Physical Activity Guide to Healthy Active Living*, highlighting the following pages and information detailed there:

- **Page 4 – Check Out What You Are Doing Now.** Is your exercise time more than 90 minutes per day? Less than 90 minutes but more than 60? Less than 60 but more than 30? Have each cadet write down their activities from yesterday and two days ago to add up their total time.
- **Page 5 – Benefits of Physical Activity.** Meet new friends, improve physical self-esteem, achieve a healthy weight, build strong bones and strengthen muscles, maintain flexibility, promote good posture and balance, improve fitness, strengthen the heart, increase relaxation and promote healthy growth and development.
- **Page 6 – What Are You Into.** Walking, running, hiking, cycling, swimming, jogging, gymnastics, ice-skating, skiing, basketball, volleyball, tobogganing, soccer, football, tennis, baseball, softball, dancing, yoga, climbing, bowling, hockey, skateboarding, badminton, etc. Have the cadets brainstorm all the activities they can think of that they may be interested in.
- **Page 8 – Let's Get Active.** Increase the time currently spent on physical activity and reduce non-active time.
- **Page 10 – Crank Up Your Activity.** Walking instead of taking the bus, playing ball at breaks, walking the dog, raking leaves, shovelling snow, carrying groceries, etc. Brainstorm ideas that will help increase current physical activity.

The purpose of highlighting these pages is to fuel the discussion for the next teaching point. The cadets may take home the guides and explore them further afterwards.

END OF LESSON CONFIRMATION

The confirmation of this lesson will occur in EO M104.02 (Section 2) as the cadets develop a personal activity plan.

CONCLUSION

HOMEWORK/READING/PRACTICE

N/A.

METHOD OF EVALUATION

There is no formal assessment of this EO.

CLOSING STATEMENT

As physical fitness is one of the aims of the cadet program, it is important that cadets learn what activities contribute to an active lifestyle to help them achieve physical fitness.

A-CR-CCP-801/PF-001

INSTRUCTOR NOTES/REMARKS

N/A.

REFERENCES

- C1-011 (ISBN 0-662-32899) Minister of Health (2002). *Canada's Physical Activity Guide to Healthy Active Living* [Brochure].
- C3-024 (ISBN 0-7627-0476-4) Roberts, H. (1989). *Basic Essentials Backpacking*. Guildford, CT: The Globe Pequot Press.

THIS PAGE INTENTIONALLY LEFT BLANK

MODIFIED LESSON INSTRUCTIONS AND INSTRUCTIONAL GUIDES – TP 1 OF EO M106.01

A-CR-CCP-801/PG-001

EO M106.01 – IDENTIFY THE PARTS AND CHARACTERISTICS OF THE DAISY 853C AIR RIFLE

1. **Performance.** Identify the Parts and Characteristics of the Daisy 853C Air Rifle.
2. **Conditions**
 - a. Given:
 - (1) Daisy 853C air rifle;
 - (2) assistance as required; and
 - (3) supervision.
 - b. Denied: N/A.
 - c. Environmental: Suitable classroom facility and/or air rifle range constructed IAW A-CR-CCP-177/PT-001, Chapter 1, sect 8.
3. **Standard.** In accordance with A-CR-CCP-177/PT-001, the cadet shall identify the parts and list the characteristics of the Daisy 853C air rifle.
4. **Teaching Points**

TP	Description	Method	Time	Ref
TP1	Identify the parts of the Daisy 853C air rifle, to include: <ol style="list-style-type: none"> a. butt plate; b. spacers; c. small of the butt; d. stock; e. fore end; f. sling bracket; g. trigger; h. trigger guard; i. safety catch; j. bolt; k. pump handle; l. front sight; m. rear sight; n. muzzle; o. barrel with barrel weight; p. bore; q. feed track; r. chamber; s. sling; t. single shot adapter; and 	Interactive Lecture	10 min	A0-027 (p. 2-5, Diagram)

TP	Description	Method	Time	Ref
	u. five-shot clip. Note: The instructor shall ensure that the cadet can identify the parts of the cadet air rifle by physically pointing to the proper part on the rifle or on an unlabeled diagram.			

5. **Time**
 - a. Introduction/Conclusion: 5 min
 - b. Interactive Lecture: 10 min
 - c. Total: 15 min

6. **Substantiation.** The interactive lecture method was chosen as it best allows the instructor to make a semi-formal presentation of the material allowing the cadets to participate by asking or responding to questions, commenting on the material, or participating in short activities. This method appeals to auditory learners, with the potential for active participation in activities that appeal to tactile/kinaesthetic learners.

7. **References.** A0-027 A-CR-CCP-177/PT-001 D Cdts 3. (2001). *Canadian Cadet Movement: Cadet Marksmanship Programme Reference Manual*. Ottawa, ON: Department of National Defence.

8. **Training Aids**
 - a. Daisy 853C air rifle; and
 - b. Presentation aids (i.e. whiteboard/flipchart/OHP) appropriate for classroom/training area.

9. **Learning Aids.** Daisy 853C air rifle.

10. **Test Details.** Assessment of this EO shall be carried out during the end of lesson check. While there is no formal assessment of this EO, every cadet is required to successfully complete the Cadet Air Rifle Handling Test provided at Chapter 3, Annex C.

11. **Remarks.** N/A.

A-CR-CCP-801/PF-001



**COMMON TRAINING
PROFICIENCY LEVEL ONE
INSTRUCTIONAL GUIDE**



SECTION 1

EO M106.01 – IDENTIFY THE PARTS AND THE CHARACTERISTICS OF THE DAISY 853C AIR RIFLE

Total Time: 15 min

PREPARATION

PRE-LESSON INSTRUCTIONS

A complete list of resources needed for the instruction of this EO is located at Chapter 4 of the QSP. Specific uses for said stores are identified throughout the Instructional Guide, within the teaching point for which they are required.

Prior to instructing this lesson the instructor shall:

- review the lesson content, and become familiar with the material;
- carry out a safety precaution check on all rifles to be used during this lesson; and
- state to cadets that the rifles have been inspected and are safe to handle.

PRE-LESSON ASSIGNMENT

N/A.

APPROACH

This lesson will be presented using the interactive lecture method. The interactive lecture method was chosen as it best allows the instructor to make a semi-formal presentation of the material allowing the cadets to participate by asking or responding to questions, commenting on the material, or participating in short activities. This method appeals to auditory learners, with the potential for active participation in activities that appeal to tactile/ kinaesthetic learners.

INTRODUCTION

REVIEW

N/A.

OBJECTIVES

By the end of this lesson the cadet shall be expected to identify the parts, and list the characteristics of the cadet air rifle.

A-CR-CCP-801/PF-001

IMPORTANCE

Cadets must have a basic knowledge of the cadet air rifle in order to understand how the rifle works and to safely follow directions given on the range.

Teaching Point 1

Identify the Parts of the Daisy 853C Air Rifle

Time: 10 min

Method: Interactive Lecture

PARTS



- Depending on the number of rifles available, distribute them with an optimum ratio of one rifle for every two cadets.
- When possible, have a second instructor in the room to assist.
- **For safety purposes, maintain strict class control at all times.**

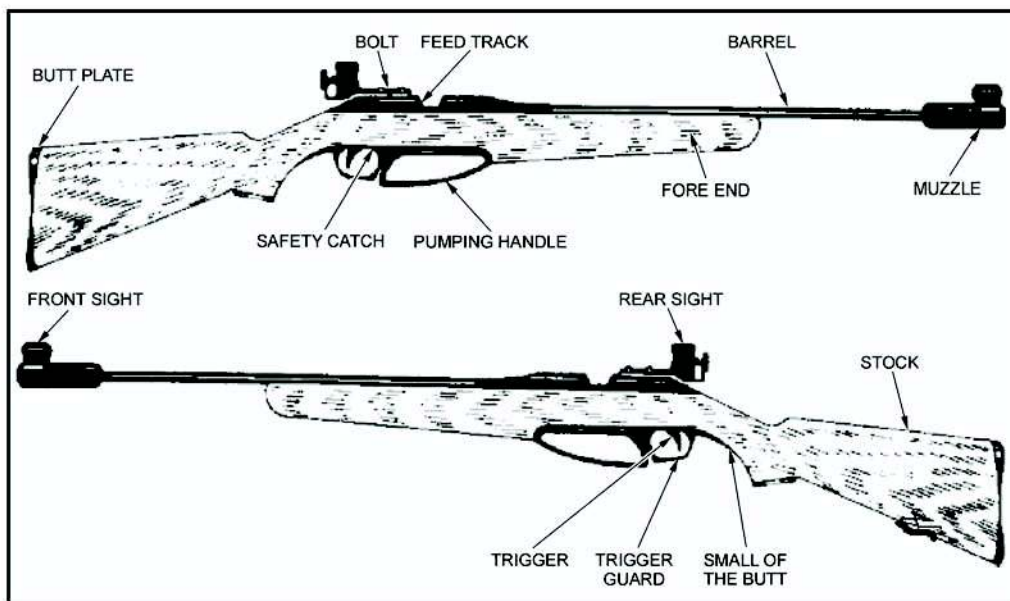

A-CR-CCP-177/PT-001

Figure 6-1-1 Parts of the Cadet Air Rifle

Butt Plate (End of the Butt). It is the part of the rifle directly in contact with the marksman's shoulder. When fitted properly, the butt plate aids in achieving a snug fit, and a consistent placement of the rifle into the shoulder. The addition of butt spacers allows for this adjustment in length.

Spacers. Plastic inserts that can be added or removed from the butt plate to vary its length. To add or take away butt spacers, use a Phillips screwdriver to loosen the butt plate and slide in/out the amount of spacers desired.

A-CR-CCP-801/PF-001

Small of the Butt (Pistol Grip). Curved area directly behind the trigger guard where the hand controlling the trigger grips the rifle.

Stock. Complete wooden portion of the rifle (from the butt plate end forward).

Fore End (of the Stock). Wooden portion of the stock from the trigger guard forward, in which the barrel and the rifle mechanism are encased.

Sling. It is a web sling made of nylon. Links the rifle to the marksman's arm to support most of the weight of the rifle. One end attaches to the sling bracket and the other to the upper arm.

Sling Bracket (Hand Stop). Adjustable metal clasp attached to the fore stock used to affix the sling to the rifle. It also acts as a hand stop, used to rest the left hand to prevent it from moving.

Trigger. Movable device that releases a spring and releases the rifle mechanism. This rifle has a single stage trigger that cannot be adjusted for weight.

Trigger Guard. Metal band that surrounds and protects the trigger.

Safety Catch. This is a mechanism that, once engaged, prevents the rifle from firing by locking the trigger in place. It is a cross bolt type device located on the trigger guard. The black side indicates that the rifle is unable to fire; the red side indicates the rifle is ready to fire. It should be ON (no red) at all times, unless firing.

Bolt. Metal lever used for opening or closing the rifle mechanism. It must be in the closed position in order to fire. For maximum safety when the rifle is uncased and not firing, the bolt should be kept open.

Pump Handle. Metal lever used to compress the air required to fire the pellet. Whenever the rifle is in a "safe rifle status", the pump lever should be left partially open.

Front Sight. Global front sight that uses aperture inserts.

Rear Sight. Micrometer sight adjustable for windage and elevation. It is easily attached to a metal rail located above the action. This rail allows for adjustment of the sight forward or backward, in order to maintain proper eye relief. The sight is attached using a small flat-blade screwdriver.

Muzzle. Front end of the barrel equipped with attachable barrel weight.

Barrel With Barrel Weight. Steel tube through which the pellet travels, extending from the muzzle to the chamber. The barrel weight ensures that the rifle's weight is evenly distributed and that the rifle's balance is maintained.

Bore. Interior of the barrel has spiral grooves cut into it. The lands are the ridges of metal between the grooves. Together, the grooves and lands are called rifling.

Feed Track. Delicate area where the pellet is inserted manually onto a single pellet adapter, or with a five-shot clip.

Single Shot Adapter. Plastic clip that aids in placing a pellet in the chamber.

Five-shot Clip. Plastic clip that holds a maximum of five pellets and used to place the pellets in the chamber.

Chamber. Location where the pellet is held before firing.

CONFIRMATION OF TEACHING POINT 1

The instructor shall ensure that the cadet can identify the parts of the cadet air rifle by physically pointing to the parts, and having the cadets properly name the part.

A-CR-CCP-801/PF-001

END OF LESSON CONFIRMATION

This EO may be confirmed with the handout found at [Annex A](#). Allow cadets a few minutes to complete the annex, then have cadets switch sheets for correcting.



Correctly labelled diagram is located at page 6A-2.

CONCLUSION

HOMEWORK/READING/PRACTICE

Cadets are to take home the corrected handout to study the parts of the cadet air rifle.

METHOD OF EVALUATION

The instructor will confirm cadets' ability to identify the parts and characteristics of the cadet air rifle by asking questions during the end of lesson confirmation, and with the handout found at Annex A.

CLOSING STATEMENT

Knowing the parts and characteristics of the cadet air rifle is important in understanding how the rifle works. This allows the cadet to be able to follow directions given on the range, and properly perform a handling test whenever an air rifle is to be used.

INSTRUCTOR NOTES/REMARKS

Emphasis must be placed on the safety aspect of this lesson.

REFERENCES

A0-027 A-CR-CCP-177/PT-001 D Cdts 3. (2001). *Canadian Cadet Movement: Cadet Marksmanship Programme Reference Manual*. Ottawa, ON: Department of National Defence.

PARTS AND CHARACTERISTICS OF THE CADET AIR RIFLE

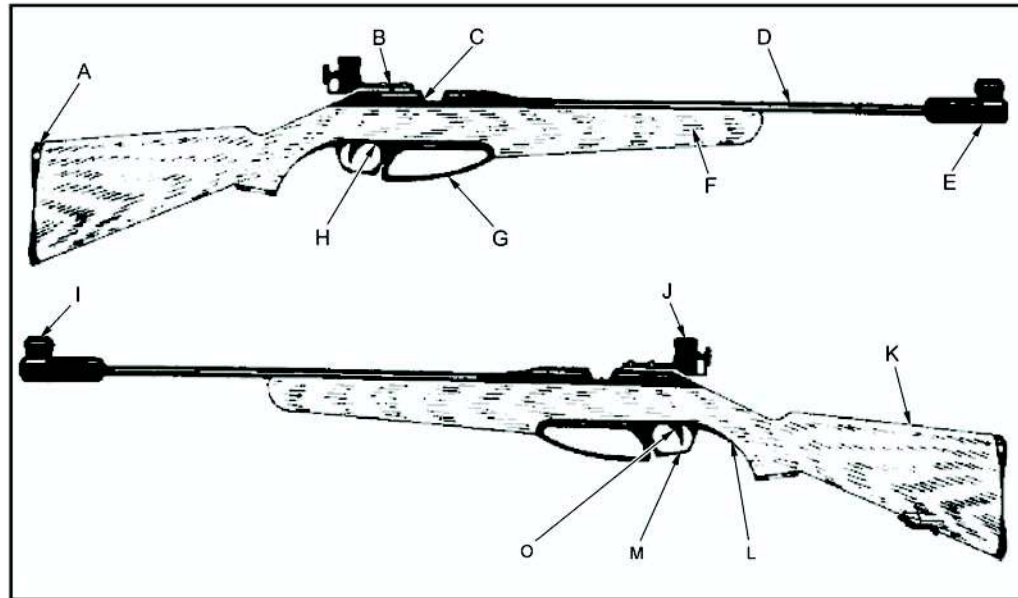

Put the letter next to the matching name of the part of the cadet air rifle.

- | | | | |
|----------------------|-------|-------------------|-------|
| 1. Feed Track | _____ | 8. Safety Catch | _____ |
| 2. Small of the Butt | _____ | 9. Muzzle | _____ |
| 3. Barrel | _____ | 10. Pump Lever | _____ |
| 4. Fore End | _____ | 11. Front Sight | _____ |
| 5. Rear Sight | _____ | 12. Trigger Guard | _____ |
| 6. Trigger | _____ | 13. Butt Plate | _____ |
| 7. Bolt | _____ | 14. Stock | _____ |

A-CR-CCP-801/PF-001
 Chapter 6, Annex A

ANSWER KEY

Y327PF0031.HF

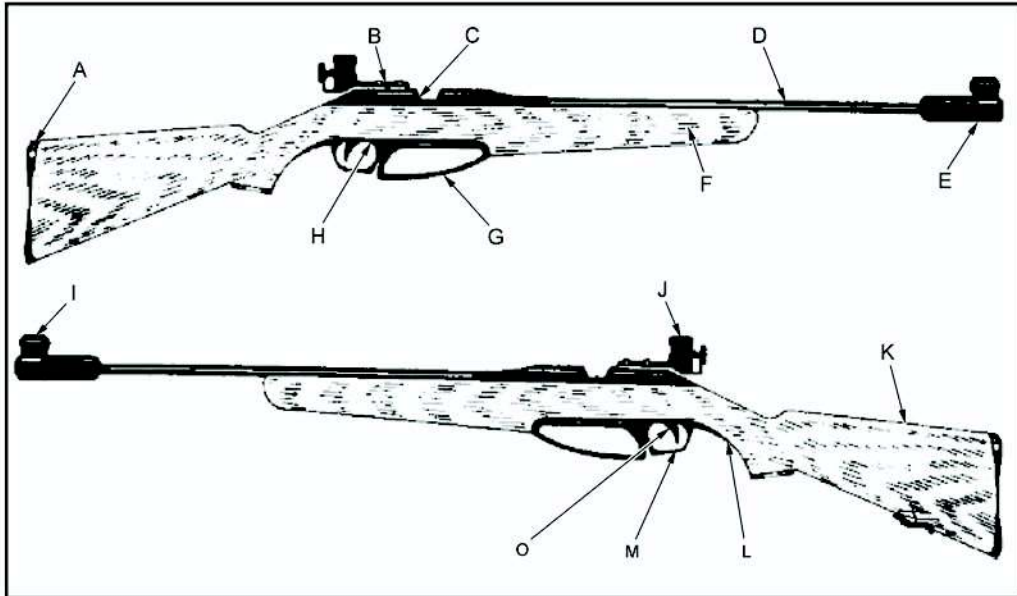

Put the letter next to the matching name of the part of the cadet air rifle.

- | | | | |
|----------------------|--------------------------|-------------------|--------------------------|
| 1. Feed Track | <u> C </u> | 8. Safety Catch | <u> H </u> |
| 2. Small of the Butt | <u> L </u> | 9. Muzzle | <u> E </u> |
| 3. Barrel | <u> D </u> | 10. Pump Lever | <u> G </u> |
| 4. Fore End | <u> F </u> | 11. Front Sight | <u> I </u> |
| 5. Rear Sight | <u> J </u> | 12. Trigger Guard | <u> M </u> |
| 6. Trigger | <u> O </u> | 13. Butt Plate | <u> A </u> |
| 7. Bolt | <u> B </u> | 14. Stock | <u> K </u> |

MODIFIED LESSON INSTRUCTIONS AND INSTRUCTIONAL GUIDES – TP 4 OF EO M106.03

A-CR-CCP-801/PG-001

EO M106.03 – APPLY BASIC MARKSMANSHIP TECHNIQUES

1. **Performance.** Apply Basic Marksmanship Techniques.
2. **Conditions**
 - a. Given:
 - (1) cadet air rifle;
 - (2) single pellet adaptor
 - (3) assistance as required; and
 - (4) supervision.
 - b. Denied: N/A.
 - c. Environmental: Suitable classroom facility and/or air rifle range constructed IAW A-CR-CCP-177/PT-001, Chapter 1, sect 8.
3. **Standard.** In accordance with A-CR-CCP-177/PT-001, the cadet shall apply basic marksmanship techniques, to include:
 - a. loading;
 - b. unloading; and
 - c. preparing for inspection.
4. **Teaching Points**

TP	Description	Method	Time	Ref
TP4	Explain, demonstrate, and have the cadets load, unload, and prepare for inspection the cadet air rifle, as follows: <ol style="list-style-type: none"> a. loading the cadet air rifle, to include: <ol style="list-style-type: none"> (1) picking up the rifle with the left hand; (2) ensuring safety catch is in the ON position; (3) pumping the air rifle, pausing for three seconds; (4) bringing pump handle back to closed position; (5) loading a pellet; and (6) closing the bolt; b. unloading the cadet air rifle, to include: <ol style="list-style-type: none"> (1) opening the bolt (do not insert a pellet); (2) pumping the air rifle, pausing for three seconds; (3) closing the bolt (do not insert a pellet); 	Demonstration and Performance	10 min	A0-027 (p. 2-16)

TP	Description	Method	Time	Ref
	<p>(4) placing the safety catch in the OFF position;</p> <p>(5) aiming the rifle at the target;</p> <p>(6) squeezing the trigger;</p> <p>(7) placing the safety catch in the ON position; and</p> <p>c. preparing for inspection, to include:</p> <p>(1) opening the bolt;</p> <p>(2) opening the pump handle slightly;</p> <p>(3) placing the rifle on the shoulder, muzzle pointed down range;</p> <p>(4) waiting to be cleared by the RSO; and</p> <p>(5) laying the rifle down.</p> <p>Note: Cadets will be required to perform these skills during their air rifle handling test. The pellet guide shall be used for training, although cadets may be introduced to the five-round clip prior to actual firing.</p>			

5. **Time**

- | | |
|-----------------------------------|--------|
| a. Introduction/Conclusion: | 5 min |
| b. Demonstration and Performance: | 10 min |
| c. Total: | 15 min |

6. **Substantiation.** The demonstration-performance method was chosen to allow cadets to participate in supervised exploration of practical instructional material. This method provides the instructor the opportunity to introduce the subject matter, demonstrate and explain procedures, and supervise the cadets while they imitate the skill. This method appeals to all learning styles.

7. **References.** A0-027 A-CR-CCP-177/PT-001 D Cdts 3. (2001). *Canadian Cadet Movement: Cadet Marksmanship Programme Reference Manual*. Ottawa, ON: Department of National Defence.

8. **Training Aids**

- Presentation aids (i.e. whiteboard/flipchart/OHP) appropriate for classroom/training area; and
- Cadet air rifle.

9. **Learning Aids.** Cadet air rifle.

10. **Test Details.** N/A.

11. **Remarks.** N/A.

A-CR-CCP-801/PF-001



**COMMON TRAINING
PROFICIENCY LEVEL ONE
INSTRUCTIONAL GUIDE**



SECTION 3

EO M106.03 – APPLY BASIC MARKSMANSHIP TECHNIQUES

Total Time: 15 min

PREPARATION

PRE-LESSON INSTRUCTIONS

A complete list of resources needed for the instruction of this EO is located at Chapter 4 of the QSP. Specific uses for said stores are identified throughout the Instructional Guide, within the teaching point for which they are required.

Review the lesson content, and become familiar with the material prior to delivering the lesson.

PRE-LESSON ASSIGNMENT

N/A.

APPROACH

This lesson will be presented using the demonstration and performance method. The demonstration-performance method was chosen to allow cadets to participate in supervised exploration of practical instructional material. This method provides the instructor the opportunity to introduce the subject matter, demonstrate and explain procedures, and supervise the cadets while they imitate the skill. This method appeals to all learning styles.



This lesson may be better presented using a round robin format for those squadrons with large first year groups.

INTRODUCTION

REVIEW

The pertinent review for this lesson, from EO M106.02 (Section 2), will include:

QUESTIONS

- Q1. Why are the individual safety precautions performed?
- Q2. What is the purpose of the "safety catch"?

A-CR-CCP-801/PF-001

ANTICIPATED ANSWERS

- A1. To confirm a rifle is safe.
A2. It prevents a rifle from firing by locking its trigger into place.

OBJECTIVES

By the end of this lesson the cadet shall be expected to apply basic marksmanship techniques to include:

- prone position;
- basic holding;
- basic aiming;
- loading;
- firing; and
- unloading.

Cadets will apply the knowledge gained during this lesson when they participate in any range practice.

IMPORTANCE

These techniques must all be applied in harmony. Improving one while not working on another will not produce the best results in the long run. Perfecting these techniques takes time and concentration. Cadets should remember – PRACTICE MAKES PERFECT!

Teaching Point 4

Explain and Demonstrate How To Load and Unload the Cadet Air Rifle

Time: 10 min

Method: Demonstration and Performance

LOADING THE AIR RIFLE



The instructor shall provide an EXPLANATION and DEMONSTRATION of the complete skill.

The instructor shall also provide an EXPLANATION and DEMONSTRATION of each step required to effectively complete the skill.

This will be conducted as a DRY FIRE EXERCISE ONLY.

Loading procedure:

1. Pick up the rifle with the left hand.
2. Ensure the safety catch is in the ON position.
3. Pump the air rifle, pausing for 3 seconds.
4. Bring the pump handle back to closed position.
5. Simulate loading a pellet, or load an auto indexing five-pellet clip into the feed track.

A-CR-CCP-801/PF-001

6. Close the bolt.



Cadets will IMITATE the demonstration provided by the instructor for each step within the skill. The instructor(s) will SUPERVISE the cadets during this imitation.



The following methods may be used when pumping the air rifle:

- **Option 1.** Grasp the pistol grip with the right hand. Grasp the pump handle with the left hand. Push downward with the left hand until the pump handle is fully extended. Wait for a few seconds. Using the left hand, bring the pump handle back to the stock of the rifle. The rifle should remain stationary during the pumping process and always point towards the targets.
- **Option 2.** Grasp the pistol grip with the right hand. Grasp the pump handle with the left hand. Place the butt of the rifle under the right arm or shoulder for support. Push downward with the left hand until the pump handle is fully extended. Wait for a few seconds. Using the left hand, bring the pump handle back to the stock of the rifle allowing the underarm and shoulder to help hold the rifle steady when closing the pump handle. Remember that the rifle must always point towards the targets.
- **Option 3 – Coach Assistance.** Point the rifle in a safe direction and request the assistance from a coach. The coach should move in and pump the rifle using both hands. This should be used as last resorts as any cadet can easily do the above two options.

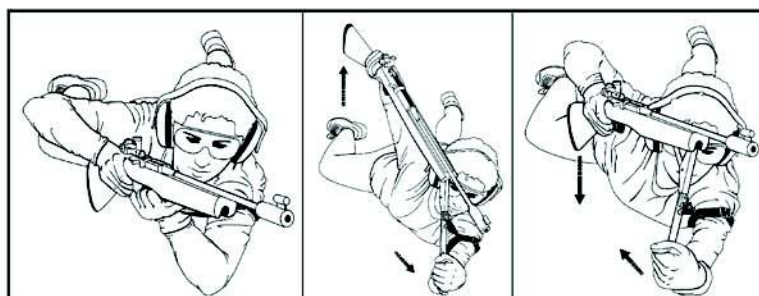

Cadet Marksmanship Program Reference Manual

Figure 6-3-7 Pumping the Air Rifle



Do not pump the rifle more than once per shot. This air rifle is designed to withstand the pressure based on a single pump stroke.



The instructor shall provide an EXPLANATION and DEMONSTRATION of the complete skill.

The instructor shall also provide an EXPLANATION and DEMONSTRATION of each step required to effectively complete the skill.

A-CR-CCP-801/PF-001

UNLOADING THE CADET AIR RIFLE

Follow the unloading sequence of the cadet air rifle, to include:

UNLOAD

1. Pick up the air rifle.
2. Remove five-pellet clip (if used).
3. Open the bolt (do not insert a pellet).
4. Pump the air rifle, pausing for 3 seconds.
5. Close the bolt (do not insert a pellet).
6. Place the safety catch in the OFF position.
7. Aim the rifle at the target.
8. Squeeze the trigger.
9. Place the safety catch in the ON position.

PREPARE FOR INSPECTION

1. Open the bolt.
2. Open the pump handle slightly.
3. Place the rifle on shoulder, muzzle pointed down range.
4. Wait to be cleared by the RSO.
5. Lay the rifle down.



Cadets will IMITATE the demonstration provided by the instructor for each step within the skill. The instructor(s) will SUPERVISE the cadets during this imitation.

CONFIRMATION OF TEACHING POINT 4



The instructor will divide the group into two, or by the number of air rifles available. The instructor shall have one group imitate the actions of the sequence as demonstrated, while the remainder observe. Have them trade places, and repeat.

END OF LESSON CONFIRMATION

The instructor will divide the group into two, or by the number of air rifles available. The instructor shall have one group imitate the actions of the sequence for all teaching points as demonstrated, while the remainder observe, and then have them trade places, and repeat.

A-CR-CCP-801/PF-001

CONCLUSION

HOMEWORK/READING/PRACTICE

N/A.

METHOD OF EVALUATION

N/A.

CLOSING STATEMENT

The first principle of marksmanship is to find a comfortable shooting position. A comfortable shooting position will enable cadets to shoot safely and with much better results. The prone position is the most stable shooting position to use.

INSTRUCTOR NOTES/REMARKS

1. Emphasis must be placed on the safety aspects of this lesson.
2. Ensure thorough confirmation by stages.

REFERENCES

A0-027 A-CR-CCP-177/PT-001 D Cdts 3. (2001). *Canadian Cadet Movement: Cadet Marksmanship Programme Reference Manual*. Ottawa, ON: Department of National Defence.

THIS PAGE INTENTIONALLY LEFT BLANK

MODIFIED LESSON INSTRUCTIONS AND INSTRUCTIONAL GUIDES – TP 1 OF EO M203.01

A-CR-CCP-802/PG-001

EO M203.01 – DISCUSS LEADERSHIP WITHIN A PEER SETTING

1. **Performance.** Discuss Leadership Within a Peer Setting.
2. **Conditions**
 - a. Given:
 - (1) supervision; and
 - (2) assistance as required.
 - b. Denied: N/A.
 - c. Environmental: Suitable classroom facilities or training area large enough to accommodate the entire group.
3. **Standard.** The cadet shall discuss leadership within a peer setting.

4. **Teaching Points**

TP	Description	Method	Time	Ref
TP1	Explain leadership within a peer setting, to include: <ol style="list-style-type: none"> a. responsibilities of a Proficiency Level Two cadet, to include: <ol style="list-style-type: none"> (1) following the chain of command; (2) setting the example; (3) being firm, fair and friendly; (4) being respectful to superiors and subordinates; (5) being aware of safety hazards; (6) displaying initiative; and (7) setting goals; and b. squadron specific Proficiency Level Two cadet responsibilities. 	Interactive Lecture	10 min	C0-134

5. **Time**
 - a. Introduction/Conclusion: 5 min
 - b. Interactive Lecture: 10 min
 - c. Total: 15 min
6. **Substantiation.** An interactive lecture was chosen for TP1 to orient the cadets to junior leadership, to generate interest and present basic material.
7. **References.** C0-134 (ISBN 0-7852-7440-5) Maxwell, J. (1999). *The 21 Indispensable Qualities of a Leader: Becoming the Person Others Will Want to Follow*. Nashville, TN: Thomas Nelson Publishers.
8. **Training Aids.** Presentation aids (e.g. whiteboard/flipchart/OHP) appropriate for the classroom/training area.
9. **Learning Aids.** N/A.

10. **Test Details.** N/A.
11. **Remarks.** The list of responsibilities in TP1 is not exhaustive. For each squadron Proficiency Level Two cadet responsibilities may vary.

A-CR-CCP-802/PF-001



**COMMON TRAINING
PROFICIENCY LEVEL TWO
INSTRUCTIONAL GUIDE**



SECTION 1

EO M203.01 – DISCUSS LEADERSHIP WITHIN A PEER SETTING

Total Time: 15 min

PREPARATION

PRE-LESSON INSTRUCTIONS

Resources needed for the delivery of this lesson are listed in the lesson specification located in A-CR-CCP-802/PG-001, Chapter 4. Specific uses for said resources are identified throughout the Instructional Guide within the TP for which they are required.

Review the lesson content and become familiar with the material prior to delivering the lesson.

The list of responsibilities of Proficiency Level Two cadets will vary for each corps. Information about the specific responsibilities should be available in the corps Standing Orders or by speaking to the corps Commanding Officer/Training Officer.

PRE-LESSON ASSIGNMENT

N/A.

APPROACH

An interactive lecture was chosen for TP1 to orient the cadets to leadership within a peer setting, to generate interest and to present basic material.

INTRODUCTION

REVIEW

N/A.

OBJECTIVES

By the end of this lesson the cadet shall be expected to discuss leadership within a peer setting.

IMPORTANCE

It is important for cadets to learn about leadership within a peer setting because there are responsibilities for second year cadets. Being aware of the responsibilities Proficiency Level Two cadets perform will assist them in setting achievable goals and adapting to their new role as leaders in the corps.

A-CR-CCP-802/PF-001

Teaching Point 1

Explain Leadership Within a Peer Setting

Time: 10 min

Method: Interactive Lecture

Within junior leadership, there are responsibilities for a Proficiency Level Two cadet at the squadron. To make the second year of cadets a fun, challenging and dynamic experience, second year cadets should know their responsibilities.



Have cadets brainstorm a list of what they think the responsibilities of a Proficiency Level Two cadet are. As you teach each of the following points, try to match them to the cadet generated list.

There are some responsibilities common to every Proficiency Level Two cadet in the corps. They are:

- **Following the Chain of Command.** Following the chain of command ensures that all information that must be passed up and down the chain is delivered. Following the chain of command prevents gaps in the information flow.
- **Setting the Example.** A Proficiency Level Two cadet must set a personal example in dress and deportment. A good leader will never ask more of their followers and teammates than they are willing to give themselves.
- **Being Firm, Fair and Friendly With Everyone, Especially New Recruits.** No one is impressed with a Proficiency Level Two cadet who yells, least of all new cadets. A highly influential and respected Proficiency Level Two cadet is one who is consistent in their approach to people and each situation. Being approachable at all times should enable the cadet to fulfill all duties and responsibilities in an effective manner.
- **Being Respectful to Superiors and Subordinates.** Using a proper tone of voice, looking people in the eyes when they speak and standing up straight is a physical way to show respect. If the Proficiency Level Two cadet wishes to be treated with respect, they must display respect toward others.
- **Being Aware of Safety Hazards.**
- **Displaying Initiative.** Undertaking small matters, like cleaning up, before being told to do so is an example of using initiative. Superiors notice when small tasks are completed without any request to do so.
- **Setting Goals.** Every leader needs to set goals. Goals allow people the opportunity to turn ideas into results. A goal is a glimpse of the future. Setting goals like improving their drill, dress and deportment, gives Proficiency Level Two cadets something to strive for. By setting goals, and working towards them, a Proficiency Level Two cadet will show commitment.



If the corps has no specific duties for Proficiency Level Two cadets, do not teach the following point.

There are specific responsibilities of a Proficiency Level Two cadet in this corps.

A-CR-CCP-802/PF-001



Explain the corps specific Proficiency Level Two cadet responsibilities.

CONFIRMATION OF TEACHING POINT 1

QUESTIONS

- Q1. List the responsibilities of Proficiency Level Two cadets in the corps.
- Q2. Why is setting goals important for a Proficiency Level Two cadet?
- Q3. List the specific Proficiency Level Two cadet duties and responsibilities for your squadron.

ANTICIPATED ANSWERS

- A1. The responsibilities of every Proficiency Level Two cadet in the squadron are:
- following the chain of command;
 - setting the example;
 - being firm, fair and friendly with everyone, especially new recruits;
 - being respectful towards your superiors and subordinates;
 - being aware of safety hazards;
 - displaying initiative; and
 - setting goals.
- A2. By setting goals and working towards them, the Proficiency Level Two cadet will show commitment.
- A3. Answers will vary.

END OF LESSON CONFIRMATION

The cadets' participation in TP1 will serve as the confirmation of this lesson.

CONCLUSION

HOMEWORK/READING/PRACTICE

N/A.

METHOD OF EVALUATION

N/A.

A-CR-CCP-802/PF-001

CLOSING STATEMENT

In order for a cadet to be successful in the role of a Proficiency Level Two, they must know their responsibilities. By setting personal short and long term goals, cadets have something to work toward and may be more motivated to complete the tasks ahead.

INSTRUCTOR NOTES/REMARKS

N/A.

REFERENCES

C0-134 (ISBN 0-7852-7440-5) Maxwell, J. (1999). *The 21 Indispensable Qualities of a Leader: Becoming the Person Others Will Want to Follow*. Nashville, TN: Thomas Nelson Publishers.

MODIFIED LESSON INSTRUCTIONS AND INSTRUCTIONAL GUIDES – TPs 1 AND 2 OF EO M129.01

A-CR-CCP-801/PG-001

EO M129.01 – RECITE THE PHONETIC ALPHABET

1. **Performance.** Recite the Phonetic Alphabet.
2. **Conditions**
 - a. Given:
 - (1) supervision; and
 - (2) assistance as required.
 - b. Denied: N/A.
 - c. Environmental: Suitable classroom facilities to accommodate the entire group.
3. **Standard.** The cadet shall recite the phonetic alphabet and numbers.
4. **Teaching Points**

TP	Description	Method	Time	Ref
TP1	Describe the phonetic alphabet from A to Z. Each letter is associated with a word that can be more easily understood over the radio.	Interactive Lecture	5 min	A3-001 (p. 205)
TP2	Identify the phonetic numbers from zero to nine. Explain that: <ol style="list-style-type: none"> a. numbers are always spoken as single digits, except for whole thousands; and b. symbols are spoken out as words over the radio, for example, the word "decimal" is used where there is a number with a decimal point. 	Interactive Lecture	5 min	A3-001 (p. 205)

5. **Time**
 - a. Introduction/Conclusion: 5 min
 - b. Interactive Lecture: 10 min
 - c. Total: 15 min
6. **Substantiation.** The interactive lecture method was chosen as it allows the instructor to make a semi-formal presentation of the material where the cadets can participate by asking or responding to questions and commenting on the material. For this lesson, this method is most effective as it matches well the taxonomic level of the material and is age-appropriate by virtue of its participatory nature.
7. **References.** A3-001 A-CR-CCP-263/PT-001 *From the Ground Up: Millennium Edition.* (2000). Ottawa, ON: Aviation Publishers Co. Limited.
8. **Training Aids.** Presentation aids (i.e. whiteboard/flipchart/OHP/multimedia projector) appropriate for classroom/training area.
9. **Learning Aids.** N/A.

10. **Test Details.** N/A.
11. **Remarks.** N/A.



ROYAL CANADIAN AIR CADETS
PROFICIENCY LEVEL ONE
INSTRUCTIONAL GUIDE



EO M129.01 – RECITE THE PHONETIC ALPHABET

Total Time: 15 min

PREPARATION

PRE-LESSON INSTRUCTIONS

A complete list of resources needed for the instruction of this EO is located at Chapter 4 of the QSP. Specific uses for said stores are identified throughout the Instructional Guide, within the teaching points for which they are required.

Review the lesson content, and become familiar with the material prior to delivering the lesson.

PRE-LESSON ASSIGNMENT

N/A.

APPROACH

The interactive lecture method was chosen as it allows the instructor to make a semi-formal presentation of the material where the cadets can participate by asking or responding to questions and commenting on the material. For this lesson, this method is most effective as it matches well the taxonomic level of the material and is age-appropriate by virtue of its participatory nature.

INTRODUCTION

REVIEW

N/A.

OBJECTIVES

By the end of this lesson the cadet shall have recited the phonetic alphabet.

IMPORTANCE

It is important to know how to properly say the alphabet and numbers while communicating over a radio. This knowledge will help avoid confusion through the pronunciation of letters and numbers and the misinterpretation of messages. Cadets can use this information during flying and aircrew survival training.

A-CR-CCP-801/PF-001

Teaching Point 1

Describe the Phonetic Alphabet

Time: 5 min

Method: Interactive Lecture

PHONETIC ALPHABET

The phonetic alphabet is used because letters that sound similar might be confused when said over a radio. An example of similar sounding letters is “**M**” and “**N**”. Therefore, each letter of the alphabet is associated with a word that is easily understood over the radio.

The phonetic alphabet is as follows:

- A – Alpha
- B – Bravo
- C – Charlie
- D – Delta
- E – Echo
- F – Foxtrot
- G – Golf
- H – Hotel
- I – India
- J – Juliet
- K – Kilo
- L – Lima
- M – Mike
- N – November
- O – Oscar
- P – Papa
- Q – Quebec
- R – Romeo
- S – Sierra
- T – Tango
- U – Uniform
- V – Victor
- W – Whiskey
- X – X-ray

A-CR-CCP-801/PF-001

- Y – Yankee
- Z – Zulu

Use of the phonetic alphabet can be heard on a familiarization flight when the pilot communicates the aircraft's call letters to the tower.

CONFIRMATION OF TEACHING POINT 1

QUESTIONS

- Q1. Why is the phonetic alphabet used?
- Q2. How is "Y" pronounced using the phonetic alphabet?
- Q3. How is "H" pronounced using the phonetic alphabet?

ANTICIPATED ANSWERS

- A1. To avoid confusion between letters that sound alike.
- A2. Yankee.
- A3. Hotel.

Teaching Point 2

Identify the Phonetic Numbers

Time: 5 min

Method: Interactive Lecture

PHONETIC NUMBERS

Phonetic numbers are used to avoid misunderstandings when using radio communication. Numbers are enunciated in the following manner:

- 0 – Zee-ro
- 1 – Wun
- 2 – Too
- 3 – Tree
- 4 – Fow-er
- 5 – Fife
- 6 – Six
- 7 – Seven
- 8 – Ait
- 9 – Nin-er

Numbers are always spoken as single digits, except for whole thousands. For example, 5280 would be spoken "fife too ait zee-ro" and 5000 would be spoken "fife tou-sand."

Symbols are spoken out as words over the radio; e.g. the word decimal, pronounced "day-see-mal", is used where there is a number with a decimal point.

A-CR-CCP-801/PF-001

Air traffic controllers use phonetic numbers to communicate to pilots what runway to use when taking off and landing.

CONFIRMATION OF TEACHING POINT 2

QUESTIONS

- Q1. How is the number one pronounced?
- Q2. How is the number four pronounced?
- Q3. How is 1289 pronounced?

ANTICIPATED ANSWERS

- A1. Wun.
- A2. Fow-er.
- A3. Wun too ait nin-er.

END OF LESSON CONFIRMATION

QUESTIONS

- Q1. How is the letter N pronounced?
- Q2. How is the letter U pronounced?
- Q3. How is the number four pronounced?
- Q4. How is 629.03 pronounced?

ANTICIPATED ANSWERS

- A1. November.
- A2. Uniform.
- A3. Fow-er.
- A4. Six too nin-er day-see-mal zee-ro tree.

CONCLUSION

HOMEWORK/READING/PRACTICE

N/A.

METHOD OF EVALUATION

N/A.

CLOSING STATEMENT

Knowledge of the proper way to use the alphabet and numbers is essential to ensure radio messages are transmitted and understood properly. This knowledge ensures the proper use of voice procedures during flying training and aircrew survival training.

A-CR-CCP-801/PF-001

INSTRUCTOR NOTES/REMARKS

N/A.

REFERENCES

A3-001 A-CR-CCP-263/PT001, *From the Ground Up: Millennium Edition* (2000). Ottawa, ON: Aviation Publishers.

THIS PAGE INTENTIONALLY LEFT BLANK

MODIFIED LESSON INSTRUCTIONS AND INSTRUCTIONAL GUIDES – TP 3 OF EO M129.01

A-CR-CCP-801/PG-001

EO M129.01 – RECITE THE PHONETIC ALPHABET

1. **Performance.** Recite the Phonetic Alphabet.
2. **Conditions**
 - a. Given:
 - (1) supervision; and
 - (2) assistance as required.
 - b. Denied: N/A.
 - c. Environmental: Suitable classroom facilities to accommodate the entire group.
3. **Standard.** The cadet shall recite the phonetic alphabet and numbers.

4. **Teaching Points**

TP	Description	Method	Time	Ref
TP1	Conduct an activity where the cadets are required to spell their name phonetically.	In-class Activity	10 min	A3-001 (p. 205)

5. **Time**
 - a. Introduction/Conclusion: 5 min
 - b. In-class Activity: 10 min
 - c. Total: 15 min
6. **Substantiation.** The in-class activity was selected to allow for maximum participation in the learning process. It is an interactive way to illustrate and substantiate the lesson material in a concrete manner.
7. **References.** A3-001 A-CR-CCP-263/PT-001 *From the Ground Up: Millennium Edition*. (2000). Ottawa, ON: Aviation Publishers Co. Limited.
8. **Training Aids.** Presentation aids (i.e. whiteboard/flipchart/OHP/multimedia projector) appropriate for classroom/training area.
9. **Learning Aids.** N/A.
10. **Test Details.** N/A.
11. **Remarks.** N/A.



ROYAL CANADIAN AIR CADETS
PROFICIENCY LEVEL ONE
INSTRUCTIONAL GUIDE



EO M129.01 – RECITE THE PHONETIC ALPHABET

Total Time: 15 min

PREPARATION

PRE-LESSON INSTRUCTIONS

Resources needed for the delivery of this lesson are listed in the lesson specification located in Chapter 4 of the QSP. Specific uses for said resources are identified throughout the instructional guide within the TP for which they are required.

Review the lesson content, and become familiar with the material prior to delivering the lesson.

PRE-LESSON ASSIGNMENT

N/A.

APPROACH

The in-class activity was selected to allow for maximum participation in the learning process. It is an interactive way to illustrate and substantiate the lesson material in a concrete manner.

INTRODUCTION

REVIEW

N/A.

OBJECTIVES

By the end of this lesson the cadet shall recited the phonetic alphabet.

IMPORTANCE

It is important to know how to properly say the alphabet and numbers while communicating over a radio. This knowledge will help avoid confusion through the pronunciation of letters and numbers and the misinterpretation of messages. Cadets can use this information during flying and aircrew survival training.

A-CR-CCP-801/PF-001

Teaching Point 1	Conduct an Activity Where the Cadets are Required to Spell Their Name Phonetically
-------------------------	---

Time: 10 min

Method: In-Class Activity

ACTIVITY

OBJECTIVE

The objective of this activity is for cadets to spell out their name using the phonetic alphabet.

RESOURCES

N/A.

ACTIVITY LAYOUT

N/A.

ACTIVITY INSTRUCTIONS

1. Divide the class into two teams.
2. Have a cadet spell their first name using the phonetic alphabet.
3. Each cadet that spells their name correctly receives one point for their team.
4. Alternate between teams.
5. Repeat step 2 and 3.
6. Once every cadet has gone, have each cadet spell their last name using the phonetic alphabet.
7. Have each cadet a number to pronounce as well.
8. The team with the most points wins the game.

SAFETY

N/A.

CONFIRMATION OF TEACHING POINT 1

The cadets' participation in the in-class activity will serve as confirmation of this TP.

END OF LESSON CONFIRMATION

The cadets' participation in the in-class activity will serve as confirmation of this lesson.

CONCLUSION

HOMEWORK/READING/PRACTICE

N/A.

METHOD OF EVALUATION

N/A.

CLOSING STATEMENT

Knowledge of the proper way to use the alphabet and numbers is essential to ensure radio messages are transmitted and understood properly. This knowledge ensures the proper use of voice procedures during flying training and aircrew survival training.

INSTRUCTOR NOTES/REMARKS

N/A.

REFERENCES

A3-001 A-CR-CCP-263/PT001, *From the Ground Up: Millennium Edition* (2000). Ottawa, ON: Aviation Publishers.

MODIFIED LESSON INSTRUCTIONS AND INSTRUCTIONAL GUIDES – TP 1 OF EO M130.02

A-CR-CCP-801/PG-001

EO M130.02 – DESCRIBE THE MAIN COMPONENTS OF AN AIRPLANE

1. **Performance.** Describe the Main Components of an Airplane.
2. **Conditions**
 - a. Given:
 - (1) supervision; and
 - (2) assistance as required.
 - b. Denied: N/A.
 - c. Environmental: Suitable classroom facilities/training facilities to accommodate the entire group.
3. **Standard.** The cadets shall identify and describe the five major components of an airplane, to include:
 - a. fuselage;
 - b. wings;
 - c. empennage;
 - d. landing gear; and
 - e. propulsion system.

4. **Teaching Points**

TP	Description	Method	Time	Ref
TP1	Identify and explain the components of an airplane, to include: <ol style="list-style-type: none"> a. fuselage; b. wings; c. empennage; d. landing gear; and e. propulsion system. 	Interactive Lecture	10 min	A3-001 (p. 9-13)

5. **Time**
 - a. Introduction/Conclusion: 5 min
 - b. Interactive Lecture: 10 min
 - c. Total: 15 min
6. **Substantiation.** The interactive lecture method was chosen as it allows the instructor to make a semi-formal presentation of the material where the cadets can participate by asking or responding to questions and commenting on the material. For this lesson, this method is most effective as it matches well the taxonomic level of the material and is age-appropriate by virtue of its participatory nature.
7. **References.** A3-001 A-CR-CCP-263/PT-001, *From the Ground Up: Millennium Edition*. (2000). Ottawa, ON: Aviation Publishers Co. Limited.

A-CR-CCP-801/PG-001

8. **Training Aids.** Presentation aids (i.e. whiteboards/flipcharts/OHP/multimedia projector) appropriate for classroom/training area.
9. **Learning Aids.** N/A.
10. **Test Details.** N/A.
11. **Remarks.** N/A.

A-CR-CCP-801/PF-001



ROYAL CANADIAN AIR CADETS
PROFICIENCY LEVEL ONE
INSTRUCTIONAL GUIDE



SECTION 2

EO M130.02 – DESCRIBE THE MAIN COMPONENTS OF AN AIRCRAFT

Total Time: 15 min

PREPARATION

PRE-LESSON INSTRUCTIONS

Resources needed for the delivery of this lesson are listed in the lesson specification located in Chapter 4 of the QSP. Specific uses for said resources are identified throughout the instructional guide within the TP for which they are required.

Review the lesson content, and become familiar with the material prior to delivering the lesson.

Photocopy the handout [Figure 12A-1](#) Components of an Airplane for each cadet, located at the end of this document.

PRE-LESSON ASSIGNMENT

N/A.

APPROACH

The interactive lecture method was chosen as it allows the instructor to make a semi-formal presentation of the material where the cadets can participate by asking or responding to questions and commenting on the material. For this lesson, this method is most effective as it matches well the taxonomic level of the material and is age-appropriate by virtue of its participatory nature.

INTRODUCTION

REVIEW

N/A.

OBJECTIVES

By the end of this lesson the cadet shall be expected to describe the main components of an airplane.

IMPORTANCE

A basic understanding of the components of an airplane will provide a foundation for further aviation topics. It will create a familiarity with airplanes that will contribute to the cadets' appreciation of the familiarization of flying and aviation tour experiences.

A-CR-CCP-801/PF-001

Teaching Point 1

Identify and Explain the Main Components of an Airplane

Time: 10 min

Method: Interactive Lecture

MAIN COMPONENTS OF AN AIRPLANE

There are five main components of an airplane.

Fuselage. The body of the aircraft, designed to accommodate the crew, passengers and cargo. The cockpit or crew flight deck is the part of the fuselage where the pilot and flight crew operate the aircraft. The fuselage is the structural body to which the wings, the tail section, landing gear and (in most small aircraft) the engine are attached.

Wings. Fitted to the fuselage on both sides. The primary purpose of the wings is to support the aircraft in flight by producing lift. The wing root is where the wing meets the fuselage. The wing tip is the part farthest from the fuselage. The leading edge is the front edge of the wing running from wing root to wing tip. The trailing edge is the back edge of the wing running from wing root to wing tip.

Empennage. Refers to the whole tail section of a plane. It includes the horizontal stabilizer, elevator, vertical stabilizer, and rudder. The horizontal stabilizer is at the back of the aircraft, and helps keep the aircraft stable as it flies through the air. The elevator is hinged to the horizontal stabilizer and is operated by moving the control column forward and backward controlling pitch. The vertical stabilizer, also called the fin, is an upright surface on the empennage. The rudder is hinged to the fin and is operated by the rudder pedals in the cockpit. The rudder controls yaw.

Landing gear. Supports the aircraft when it is on the ground and absorbs the shock of landing. All aircraft have their landing gear under the main part of the fuselage or wings. Landing gear can be fixed or retractable. Fixed gear is attached to the airplane in a permanent position. Retractable gear can fold up into the wings or the fuselage.

Propulsion. Produced by an internal combustion engine with a two or three bladed propeller or a gas turbine (jet) engine. A jet can be used to power a propeller – this is called a turboprop engine.

The cowling (also called the nacelle) encloses the engine and streamlines the airplane to reduce drag. The cowling provides cooling of the engine by ducting cool air around the engine.



Distribute the handout of [Figure 12A-1 Components of an Airplane](#), located at the end of this document.

A-CR-CCP-801/PF-001

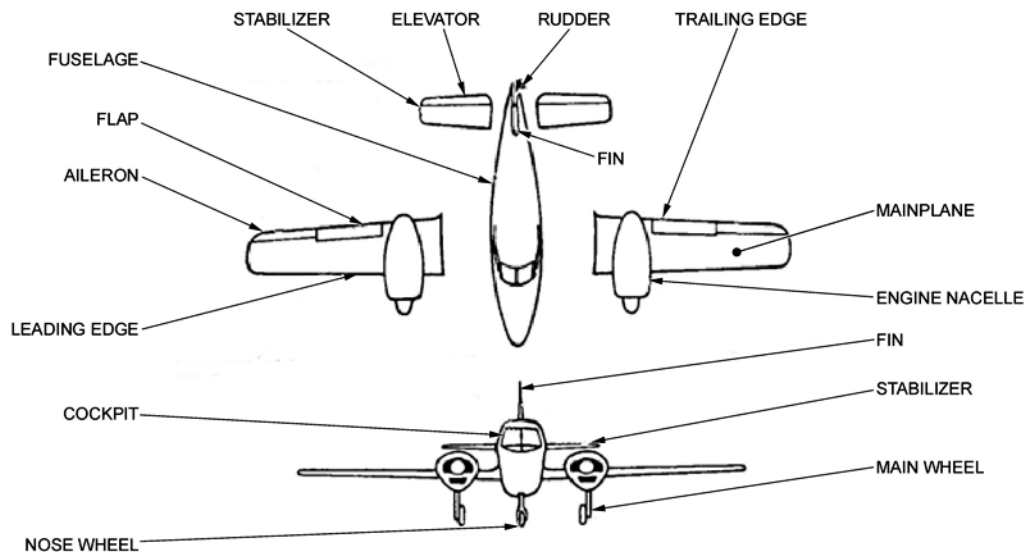

Level 1 Royal Canadian Air Cadet Handbook – A-CR-CCP-266/PT-001

Figure 12-2-1 Airplane Components

CONFIRMATION OF TEACHING POINT 1

QUESTIONS

- Q1. What is the fuselage?
- Q2. What is the primary purpose of the wings?
- Q3. Name the five main components of an airplane.

ANTICIPATED ANSWERS

- A1. The body of the aircraft, designed to accommodate the crew, passengers and cargo.
- A2. To support the aircraft in flight by producing lift.
- A3. Fuselage, wings, empennage, landing gear and propulsion system.

END OF LESSON CONFIRMATION

The questions for TP1 will serve as the confirmation of this lesson.

CONCLUSION

HOMEWORK/READING/PRACTICE

N/A.

A-CR-CCP-801/PF-001

METHOD OF EVALUATION

N/A.

CLOSING STATEMENT

Being able to describe the main components of an airplane will give cadets the knowledge needed to appreciate and successfully participate in further aviation topics.

INSTRUCTOR NOTES/REMARKS

N/A.

REFERENCES

A3-001 A-CR-CCP-263/PT-001 *From the Ground Up: Millennium Edition (28th Edition)*. (2000). Ottawa, ON: Aviation Publishers.

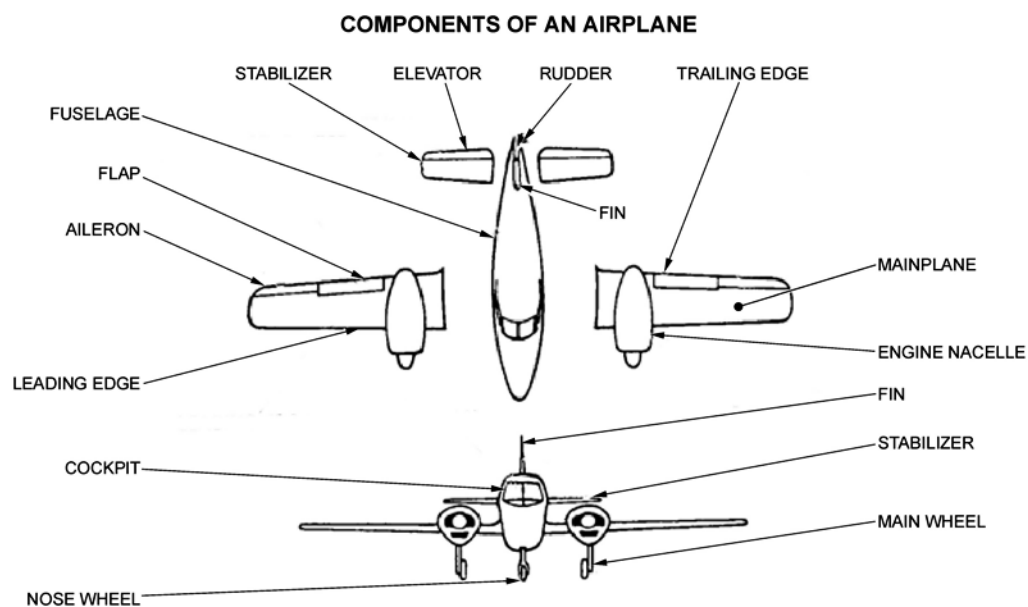

Level 1 Royal Canadian Air Cadet Handbook – A-CR-CCP-266/PT-001

Figure 12A-1 Components of an Airplane

THIS PAGE INTENTIONALLY LEFT BLANK

MODIFIED LESSON INSTRUCTIONS AND INSTRUCTIONAL GUIDES – TP 1 OF EO M160.01

A-CR-CCP-801/PG-001

EO M160.01 – IDENTIFY MAJOR AERODROME COMPONENTS

1. **Performance.** Identify Major Aerodrome Components.
2. **Conditions**
 - a. Given:
 - (1) supervision; and
 - (2) assistance as required.
 - b. Denied: N/A.
 - c. Environmental: Suitable classroom/training facilities to accommodate the entire group.
3. **Standard.** The cadets shall identify the major components of an aerodrome, to include:
 - a. runway;
 - b. taxiway;
 - c. hangars;
 - d. ramp areas;
 - e. control towers;
 - f. terminal buildings;
 - g. wind socks; and
 - h. flying schools.

4. **Teaching Points**

TP	Description	Method	Time	Ref
TP1	Identify and explain the components of an aerodrome, to include: <ol style="list-style-type: none"> a. runway, b. taxiway, c. ramp area, d. hangar, e. control tower, f. terminal building, g. wind sock, and h. flying school. 	Interactive Lecture	10 min	A3-001 (pp. 91-93 and 213) C2-002

5. **Time**

- a. Introduction/Conclusion: 5 min
- b. Interactive Lecture: 10 min
- c. Total: 15 min

A-CR-CCP-801/PG-001

6. **Substantiation.** The interactive lecture method was chosen as it allows the instructor to make a semi-formal presentation of the material where the cadets can participate by asking or responding to questions and commenting on the material. For this lesson, this method is most effective as it matches well the taxonomic level of the material and is age-appropriate by virtue of its participatory nature.
7. **References.** A3-001 A-CR-CCP-263/PT-001, *From the Ground Up: Millennium Edition*. (2000). Ottawa, ON: Aviation Publishers Co. Limited.
8. **Training Aids.** Presentation aids (i.e. whiteboard/flipcharts/OHP/multimedia projector) appropriate for classroom/training area.
9. **Learning Aids.** N/A.
10. **Test Details.** N/A.
11. **Remarks.** N/A.

A-CR-CCP-801/PF-001



ROYAL CANADIAN AIR CADETS
PROFICIENCY LEVEL ONE
INSTRUCTIONAL GUIDE



SECTION 1

EO M160.01 – IDENTIFY MAJOR AERODROME COMPONENTS

Total Time: 15 min

PREPARATION

PRE-LESSON INSTRUCTIONS

Resources needed for the delivery of this lesson are listed in the lesson specification located in Chapter 4 of the QSP. Specific uses for said resources are identified throughout the instructional guide within the TP for which they are required.

Review the lesson content, and become familiar with the material prior to delivering the lesson.

PRE-LESSON ASSIGNMENT

N/A.

APPROACH

The interactive lecture method was chosen as it allows the instructor to make a semi-formal presentation of the material where the cadets can participate by asking or responding to questions and commenting on the material. For this lesson, this method is most effective as it matches well the taxonomic level of the material and is age-appropriate by virtue of its participatory nature.

INTRODUCTION

REVIEW

N/A.

OBJECTIVES

By the end of this lesson the cadet shall be expected to identify major aerodrome components.

IMPORTANCE

It is important for cadets to know the various components of an aerodrome. This information will assist them in identifying the components during aerodrome tours and familiarization flights.

Teaching Point 1

Identify and Explain the Components of an Aerodrome

Time: 10 min

Method: Interactive Lecture

COMPONENTS OF AN AERODROME

There are nine main components of an aerodrome.

A-CR-CCP-801/PF-001

Runway. The area where aircraft take off and land. A runway may be made of pavement, grass, gravel, dirt or snow among other materials. Runways are identified by numbers and by the white lights that run along each side.

Taxiway. The area used by an aircraft to manoeuvre around the aerodrome between aprons and runways. Letters normally designate taxiways. At aerodromes with lighting, taxiways are defined by blue lights along each side.

Ramp Area. The part of an aerodrome intended to accommodate the loading and unloading of passengers and cargo. It is also the area used for refuelling, servicing and parking of aircraft. The ramp area is also known as the tarmac or apron.

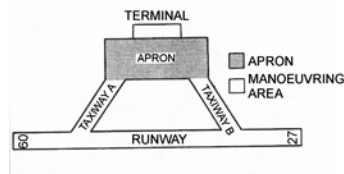

Royal Canadian Air Cadet Manual, Proficiency Level One Handbook, Cadets Canada, 1998

Figure 14-1-1 Aerodrome Movement Areas

Hangar. An aerodrome building that is used for storage, protection and maintenance of aircraft.

Control tower. Ensures the safe and efficient movement of aircraft. The air traffic controllers in the control tower are responsible for a number of procedures. These include take off / landing procedures, circuit procedures and ground manoeuvring of aircraft. Not all aerodromes have the service of a control tower.

Terminal building. Used for passengers arriving and departing. They are also used for baggage and cargo handling. Terminal buildings are normally located on the apron.

Windssock. Used by pilots to determine wind direction and speed. The approximate wind speed is indicated by the amount the windssock is extended. Every aerodromes have at least one windssock or wind-t. The wind-t is designed like an arrow whose small end points into the wind. They are found on the airfield, normally beside the runway.

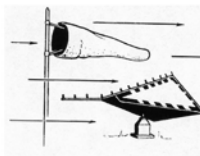

From the Ground Up : Millennium Edition, A.F. MacDonald, 2000

Figure 14-1-2 Windssock and Wind T

Flying School. Used as training facilities for current pilots and those that wish to pursue a career in aviation.

CONFIRMATION OF TEACHING POINT 1

QUESTIONS

Q1. What is the purpose of a taxiway?

A-CR-CCP-801/PF-001

- Q2. What is the purpose of a hangar?
Q3. What is the purpose of a windsock?

ANTICIPATED ANSWERS

- A1. To manoeuvre around the aerodrome between aprons and runways.
A2. An aerodrome building that is used for storage, protection and maintenance of aircraft.
A3. Used by pilots to determine wind direction and speed.

END OF LESSON CONFIRMATION

The questions from TP1 will serve as the confirmation of this lesson.

CONCLUSION

HOMEWORK/READING/PRACTICE

N/A.

METHOD OF EVALUATION

N/A.

CLOSING STATEMENT

The various areas of an aerodrome serve different purposes. As cadets, knowing the various components of an aerodrome will assist in identifying the components during tours and familiarization flights.

INSTRUCTOR NOTES/REMARKS

N/A.

REFERENCES

- A3-001 A-CR-CCP-263/PT-001, *From the Ground Up: Millennium Edition* (2000). Ottawa, ON: Aviation Publishers Co. Limited.

THIS PAGE INTENTIONALLY LEFT BLANK

MODIFIED LESSON INSTRUCTIONS AND INSTRUCTIONAL GUIDES – TPs 1 AND 2 OF EO M160.02

A-CR-CCP-801/PG-001

EO M160.02 – IDENTIFY FEATURES OF A RUNWAY

1. **Performance.** Identify Features of a Runway.
2. **Conditions**
 - a. Given:
 - (1) supervision; and
 - (2) assistance as required.
 - b. Denied: N/A.
 - c. Environmental: Suitable classroom facilities to accommodate the entire group.
3. **Standard.** The cadet shall identify features of a runway, to include:
 - a. runway lights; and
 - b. runway numbering.

4. **Teaching Points**

TP	Description	Method	Time	Ref
TP1	Identify and explain runway lights, to include that different coloured lights identify different parts of the runway.	Interactive Lecture	5 min	A3-001 (p. 93)
TP2	Identify and explain runway numbering.	Interactive Lecture	5 min	A3-001 (p. 91)

5. **Time**
 - a. Introduction/Conclusion: 5 min
 - b. Interactive Lecture: 10 min
 - c. Total: 15 min
6. **Substantiation.** The interactive lecture method was chosen as it allows the instructor to make a semi-formal presentation of the material where the cadets can participate by asking or responding to questions and commenting on the material. For this lesson, this method is most effective as it matches well the taxonomic level of the material and is age-appropriate by virtue of its participatory nature.
7. **References.** A3-001 A-CR-CCP-263/PT-001, *From the Ground Up: Millennium Edition*. (2000). Ottawa, ON: Aviation Publishers Co. Limited.
8. **Training Aids.** Presentation aids (i.e. whiteboard/flipchart/OHP/multimedia projector) appropriate for classroom/training area.
9. **Learning Aids.** N/A.
10. **Test Details.** N/A.
11. **Remarks.** N/A.



ROYAL CANADIAN AIR CADETS
PROFICIENCY LEVEL ONE
INSTRUCTIONAL GUIDE



SECTION 2

EO M160.02 – IDENTIFY FEATURES OF A RUNWAY

Total Time: 15 min

PREPARATION

PRE-LESSON INSTRUCTIONS

Resources needed for the delivery of this lesson are listed in the lesson specification located in Chapter 4 of the QSP. Specific uses for said resources are identified throughout the instructional guide within the TP for which they are required.

Review the lesson content, and become familiar with the material prior to delivering the lesson.

PRE-LESSON ASSIGNMENT

N/A.

APPROACH

The interactive lecture method was chosen as it allows the instructor to make a semi-formal presentation of the material where the cadets can participate by asking or responding to questions and commenting on the material. For this lesson, this method is most effective as it matches well the taxonomic level of the material and is age-appropriate by virtue of its participatory nature

INTRODUCTION

REVIEW

N/A.

OBJECTIVES

By the end of this lesson the cadet shall be expected to identify features of a runway.

IMPORTANCE

It is important for cadets to understand the features of a runway as it will be helpful during tours and familiarization flights. The various features of runways will be referred to in future aviation lessons at the squadron and the CSTC. In the aviation industry, pilots and air traffic controllers require this information to perform their jobs.

A-CR-CCP-801/PF-001

Teaching Point 1

Identify and Explain Runway Lights

Time: 5 min

Method: Interactive Lecture



Create a large runway on the floor, whiteboard or flipchart.

RUNWAY LIGHTS

Runways are lined down both sides by white lights. These lights are used to define the overall area of the runway on each side. Runways also contain red/green lights at the ends. These lights are double sided with red on one side and green on the other. As seen for the pilot's perspective, the red side of the lights faces toward the runway and indicates the end of the runway. The green side faces away from the runway and shows the beginning of the runway to aircraft that are landing.

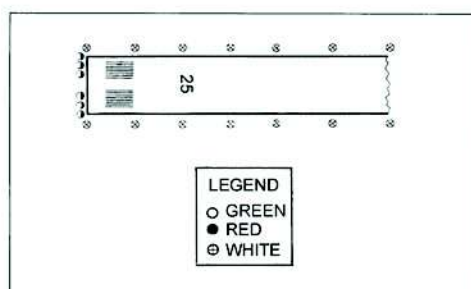

Royal Canadian Air Cadet Manual, Proficiency Level One Handbook, Cadets Canada, 1998

Figure 14-2-1 Runway Lights

CONFIRMATION OF TEACHING POINT 1

QUESTIONS

- Q1. What colour lights define the runway on each side?
- Q2. What is the importance of the red lights?
- Q3. What is the importance of the green lights?

ANTICIPATED ANSWERS

- A1. White lights.
- A2. Red lights indicate the end of the runway.
- A3. Green lights indicate the beginning of the runway.

Teaching Point 2

Identify and Explain Runway Numbering

Time: 5 min

Method: Interactive Lecture

RUNWAY NUMBERING

The runway number is always indicated in large print as a two-digit number at the end of the runway. Runways are numbered according to their magnetic direction and are rounded off to the nearest ten degrees. Once rounded, the hundreds and tens digits are used to number the runway. For example, a runway that points in the direction of 266 degrees magnetic would be numbered 27. Therefore, the highest runway number possible is 36 (360 degrees).

When runways run parallel, they are designated left or right (e.g. 27L and 27R). The runway number is displayed at the approach end of each runway. A single runway would, therefore, have different numbers at each of its two ends. These numbers would be 180 degrees apart. For example, runway 09 would be numbered 27 at the other end.

CONFIRMATION OF TEACHING POINT 2

QUESTIONS

- Q1. On what basis are runways numbered?
- Q2. If a runway points in the direction of 176 degrees magnetic, how would it be numbered?
- Q3. If a runway points in the direction of 43 degrees magnetic, how would it be numbered?

ANTICIPATED ANSWERS

- A1. Their magnetic direction.
 - A2. 18 (Round 176 to 180, and use only the hundreds and tens digits).
 - A3. 04 (Round 43 to 40, and use only the hundreds and tens digits).
-

END OF LESSON CONFIRMATION

QUESTIONS

- Q1. What colour lights define the runway on each side?
- Q2. If a runway points in the direction of 241 degrees magnetic, how would it be numbered?
- Q3. If a runway points in the direction of 358 degrees magnetic, how would it be numbered?

ANTICIPATED ANSWERS

- A1. White lights.
- A2. 24 (Round 241 to 240, and use only the hundreds and tens digits).
- A3. 36 (Round 358 to 360, and use only the hundreds and tens digits).

A-CR-CCP-801/PF-001

CONCLUSION

HOMEWORK/READING/PRACTICE

N/A.

METHOD OF EVALUATION

N/A.

CLOSING STATEMENT

Being familiar with the various features of runways can assist cadets in a number of areas of their training. Understanding the features of a runway enhances cadet knowledge of aerodrome components and gives further insight into the runways' role with respect to take-off and landing procedures of aircraft.

INSTRUCTOR NOTES/REMARKS

N/A.

REFERENCES

A3-001 A-CR-CCP-263/PT-001, *From the Ground Up: Millennium Edition* (2000). Ottawa, ON: Aviation Publishers Co. Limited.

THIS PAGE INTENTIONALLY LEFT BLANK

MODIFIED LESSON INSTRUCTIONS AND INSTRUCTIONAL GUIDES – TPs 4 AND 5 OF EO M230.01

A-CR-CCP-802/PG-001

EO M230.01 – DISCUSS AIRCRAFT FLOWN WWII

1. **Performance.** Discuss Aircraft Flown During WWII.
2. **Conditions**
 - a. Given:
 - (1) Supervision; and
 - (2) Assistance as required.
 - b. Denied: N/A.
 - c. Environmental: Suitable classroom facilities/training facilities large enough to accommodate the entire group.
3. **Standard.** The cadet shall discuss aircraft flown during the Battle of Britain.

4. **Teaching Points**

TP	Description	Method	Time	Ref
TP1	Discuss the importance of the Battle of Britain, to include: <ol style="list-style-type: none"> a. the duration of the battle fought from August 8, 1940–October 31, 1940; and b. the battle between the Allied Forces and Axis powers. 	Interactive Lecture	5 min	C3-078
TP2	Discuss the aircraft flown during the Battle of Britain, to include: <ol style="list-style-type: none"> a. the Hawker Hurricane Mark 1; and b. the Spitfire Mark 1. 	Interactive Lecture	5 min	C3-078

5. **Time**

a. Introduction/Conclusion:	5 min
b. Interactive Lecture:	10 min
c. Total:	15 min
6. **Substantiation.** An interactive lecture was chosen for this lesson to present background material to the cadets and promote an interest in aircraft flown during WWII.
7. **References.** C3-078 Canadian War Museum. (2004). *The Invasion Threat to Britain and the Battle of Britain, 1940*. Retrieved 16 February 2007, from http://www.warmuseum.ca/cwm/newspapers/operations/Britain_e.html.
8. **Training Aids.** Presentation aids (e.g. whiteboard/flipchart/OHP/multimedia projector) appropriate for the classroom/training area.
9. **Learning Aids.** N/A.

10. **Test Details.** N/A.
11. **Remarks.** N/A.



ROYAL CANADIAN AIR CADETS
PROFICIENCY LEVEL TWO
INSTRUCTIONAL GUIDE



SECTION 1

EO M230.01 – DISCUSS AIRCRAFT FLOWN DURING WWII

Total Time: 15 min

PREPARATION

PRE-LESSON INSTRUCTIONS

Resources needed for the delivery of this lesson are listed in the lesson specification located in A-CR-CCP-802/PG-001, Chapter 4. Specific uses for said resources are identified throughout the Instructional Guide within the TP for which they are required.

Review the lesson content and become familiar with the material prior to delivering the lesson.

Photocopy the handouts at [Figure 10A-5](#) The Hawker Mark 1 Hurricane and [Figure 10A-6](#) The Spitfire for each cadet, located at the end of this document.

PRE-LESSON ASSIGNMENT

N/A.

APPROACH

An interactive lecture was chosen for this lesson to present background material to the cadets and to promote an interest in aircraft flown during WWII.

INTRODUCTION

REVIEW

N/A.

OBJECTIVES

By the end of this lesson the cadet shall be expected to discuss aircraft flown during WWII.

IMPORTANCE

It is important for cadets to know about the aircraft flown in WWII so that they can better understand Canada's role during these conflicts and to commemorate the fallen men and women who gave their lives during these conflicts.

A-CR-CCP-802/PF-001

Teaching Point 1

Discuss the Importance of the Battle of Britain

Time: 5 min

Method: Interactive Lecture

THE BATTLE OF BRITAIN

The Battle of Britain was fought from August 8, 1940 until October 31, 1940.

The Battle of Britain was the first major battle to be fought wholly in the air, with both sides having roughly the same number of fighter aircraft.

It was the largest and most sustained bombing campaign yet attempted and the first real test of the strategic bombing theories that had emerged since the previous World War.

Duration of the Battle of Britain

The battle can be roughly divided into four phases:

- July 10–August 11: Kanalkampf, the Channel battles,
- August 8–August 23: Adlerangriff, the early assault against the coastal airfields,
- August 24–September 6: the Luftwaffe targets the airfields – the critical phase of the battle;
- September 7 onward: the day attacks switch to British towns and cities.

The Battle of Britain marked the first time that the Nazis were stopped and that air superiority became clearly seen as the key to the war. Though the battle was small in the number of combatants and casualties, had the Germans won, the war would have taken a very different path.

The British victory marked the first failure of Hitler's war machine.

The Royal Air Force lost 375 pilots and 358 pilots were wounded.

ALLIED FORCES AND AXIS POWERS

The Battle of Britain was between the United Kingdom and Germany and Italy.

The Battle of Britain is the name commonly given to the attempt by the German Luftwaffe, as part of German Blitzkrieg tactics, to gain air superiority over the Royal Air Force (RAF), before a planned sea and airborne invasion of Britain (Operation Sealion).

Neither Hitler nor the German Wehrmacht believed it possible to carry out a successful amphibious assault on the British Isles until the RAF had been neutralized.

Secondary objectives were to destroy aircraft production and ground infrastructure, to attack areas of political significance, and to terrorize the British people with the intent of intimidating them into seeking an armistice or surrender.

The RAF roll of honour for the Battle of Britain recognizes 510 overseas pilots as flying at least one authorized operational mission with an eligible unit of the Royal Air Force or Fleet Air Arm between July 10 and October 31, 1940. This included pilots from Poland, New Zealand, Canada, Czechoslovakia, Belgium, Australia, South Africa, France, Ireland, the United States of America, Jamaica, Palestine and Southern Rhodesia (Zimbabwe).

The highest scoring unit during the Battle of Britain is remarkably the No. 303 Polish Fighter Squadron.

A-CR-CCP-802/PF-001

CONFIRMATION OF TEACHING POINT 1

QUESTIONS

- Q1. What were the dates of the Battle of Britain?
- Q2. Who was the battle between?
- Q3. What were two of the other countries involved in the Battle of Britain?

ANTICIPATED ANSWERS

- A1. The Battle of Britain was fought from August 8, 1940 until October 31, 1940.
- A2. The Battle of Britain was between the Allied Forces and Axis powers.
- A3. Poland, New Zealand, Canada, Czechoslovakia, Belgium, Australia, South Africa, France, Ireland, the United States of America, Jamaica, Palestine and Southern Rhodesia (Zimbabwe).

Teaching Point 2

Discuss the Aircraft Flown During the Battle of Britain

Time: 5 min

Method: Interactive Lecture



Distribute handouts to the cadets of [Figure 10A-5](#) The Hawker Mark 1 Hurricane, located at the end of this document.

HAWKER HURRICANE MARK I

- The Hawker Hurricane Mark I was a single-seater fighter with a Rolls-Royce Merlin engine.
- It was a low-wing all-metal cantilever monoplane armed with eight Browning machine-guns – four in each wing set to fire forward outside the airscrew disc.
- The maximum speed was 539 km/h.
- The Hurricane was regarded as less 'twitchy' than the Spitfire and provided a more stable gun platform.
- The RAF's preferred tactic was, if possible, to deploy the Hurricane's awesome fire power against formations of less-agile bombers and to set up the Spitfires against fighter escorts waiting to pounce from a higher altitude.



Distribute handouts to the cadets of [Figure 10A-6](#) The Spitfire, located at the end of this document.

THE SPITFIRE MARK 1

- The Spitfire Mark 1 was a similar single-seater fighter with a Rolls-Royce Merlin engine.
- It was a low-wing all-metal cantilever monoplane armed with eight Browning machine-guns – four in each wing set to fire forward outside the airscrew disc.

A-CR-CCP-802/PF-001

The Spitfire's one-piece sliding moulded canopy gave the best visibility, the pilot having a better chance of spotting an enemy.

The maximum speed was 589 km/h.

QUALITIES OF BOTH AIRCRAFTS

In both these aircrafts the armour in the front and back protected the pilot.

The Spitfire and Hurricane would out-turn the Bf-109E or Emil (German Aircraft) because the Bf-109 pilots were afraid to push the plane to its limits due to the fact that the Bf-109 did not give the pilot any warning that it was going to stall, unlike the Spitfire and Hurricane, which gave the pilot plenty of warning that the plane was about to stall by shaking violently.

Both the Spitfire and Hurricane were slower in a power dive and had the drawback of being equipped with a float-type carburetor, which cut out under negative g-forces.

Both the RAF fighters were easy to fly and forgiving with both rough handling and novice pilots.

The Hurricane was a superbly steady gun platform and the closely clustered .303 machine guns in each wing proved very destructive.

A drawback to the Hurricane was the presence of a fuel tank just behind the cockpit firewall, which could catch fire and within a few seconds severely burn the pilot before he managed to bail out.

CONFIRMATION OF TEACHING POINT 2

QUESTIONS

- Q1. What was the maximum speed of the Hawker Hurricane?
- Q2. What was the maximum speed of the Spitfire Mark 1?
- Q3. What was a drawback to the Hurricane?

ANTICIPATED ANSWERS

- A1. The maximum speed of the Hawker Hurricane was 539 km/h.
- A2. The maximum speed of the Spitfire Mark 1 was 589 km/h.
- A3. A drawback to the Hurricane was the presence of a fuel tank just behind the cockpit firewall, which could catch fire and within a few seconds severely burn the pilot before he managed to bail out.

END OF LESSON CONFIRMATION

QUESTIONS

- Q1. What were the dates of the Battle of Britain?
- Q2. Who was the battle between?
- Q3. Name two Allied aircraft flown during the Battle of Britain.

ANTICIPATED ANSWERS

- A1. The Battle of Britain was fought from August 8, 1940 until October 31, 1940.

A-CR-CCP-802/PF-001

A2. The Battle of Britain was between the Allied Forces and Axis powers.

A3. Hawker Hurricane and Spitfire Mark 1.

CONCLUSION

HOMEWORK/READING/PRACTICE

N/A.

METHOD OF EVALUATION

N/A.

CLOSING STATEMENT

It is important for cadets to know about the aircraft flown in WWII so that they can better understand Canada's role during these conflicts. Learning about Canada's aviation history may assist the cadets in understanding the meaning of the parades used to commemorate the fallen men and women who gave their lives during these conflicts.

INSTRUCTOR NOTES/REMARKS

N/A.

REFERENCES

C3-078 Canadian War Museum. (2004). *The Invasion Threat to Britain and the Battle of Britain, 1940*. Retrieved 16 February 2007, from http://www.warmuseum.ca/cwm/newspapers/operations/Britain_e.html.

AIRCRAFT FLOWN DURING WWII



Department of National Defence. (2006). Canadian Forces Aircraft. Retrieved 20 March 2007, from http://www.airforce.forces.gc.ca/equip/grfx/equip_gallery/historic_gallery/wallpaper/harvarda9.jpg

Figure 10A-5 The Hawker Mark 1 Hurricane

A-CR-CCP-802/PF-001
Chapter 10, Annex A



Department of National Defence. (2006). Canadian Forces Aircraft. Retrieved 20 March 2007, from http://www.airforce.forces.gc.ca/equip/historical/spitfirelst_e.asp

Figure 10A-6 The Spitfire

THIS PAGE INTENTIONALLY LEFT BLANK

MODIFIED LESSON INSTRUCTIONS AND INSTRUCTIONAL GUIDES – TP 3 OF EO M231.02

A-CR-CCP-802/PG-001

EO M231.02 – DESCRIBE THE PRODUCTION OF LIFT BY AN AIRCRAFT WING

1. **Performance.** Describe the Production of Lift by an Aircraft Wing.
2. **Conditions**
 - a. Given:
 - (1) Supervision; and
 - (2) Assistance as required.
 - b. Denied: N/A.
 - c. Environmental: Suitable classroom facilities or training area large enough to accommodate the entire group.
3. **Standard.** The cadet shall describe the production of lift by an aircraft wing, to include:
 - a. the airfoil camber; and
 - b. angle of attack.

4. **Teaching Points**

TP	Description	Method	Time	Ref
TP1	Explain that air acts like a fluid insofar as it has: <ol style="list-style-type: none"> a. speed; and b. pressure. Have the cadets explore Bernoulli's Principle by blowing over a curved sheet of paper.	In-class Activity	10 min	C3-017 (p. 18) C3-116 (p. 21, p. 26)

5. **Time**
 - a. Introduction/Conclusion: 5 min
 - b. In-class Activity: 10 min
 - c. Total: 15 min
6. **Substantiation.** An in-class activity was chosen for TP1 as it is an interactive way to provoke thought and stimulate interest among cadets.
7. **References**
 - a. C3-017 (ISBN 1-895569-23-0) Schmidt, N. (1998). *Fabulous Paper Gliders*. New York, NY: Sterling Publishing.
 - b. C3-116 A-CR-CCP-263/PT-001 (ISBN 0-9680390-5-7) MacDonald, A. F. and Pepler, I. L. (2000). *From the Ground Up: Millennium Edition*. Ottawa, ON: Aviation Publishers Co. Limited.
8. **Training Aids**
 - a. Presentation aids (e.g. whiteboard/flipchart/OHP/multimedia projector) appropriate for the classroom/training area;
 - b. 8.5 x 11 in paper.

9. **Learning Aids.** 8.5 x 11 in paper.
10. **Test Details.** N/A.
11. **Remarks.** N/A.



ROYAL CANADIAN AIR CADETS
PROFICIENCY LEVEL TWO
INSTRUCTIONAL GUIDE



SECTION 2

EO M231.02 – DESCRIBE THE PRODUCTION OF LIFT BY AN AIRCRAFT WING

Total Time: 15 min

PREPARATION

PRE-LESSON INSTRUCTIONS

Resources needed for the delivery of this lesson are listed in the lesson specification located in A-CR-CCP-802/PG-001, Chapter 4. Specific uses for said resources are identified throughout the Instructional Guide within the TP for which they are required.

Review the lesson content and become familiar with the material prior to delivering the lesson.

Photocopy handout for each cadet of [Figure 11D-2 Creating Lift](#), located at the end of this document.

Gather resources needed for the in-class activity in TP1.

PRE-LESSON ASSIGNMENT

N/A.

APPROACH

An in-class activity was chosen for TP1 as it is an interactive way to provoke thought and stimulate interest among cadets.

INTRODUCTION

REVIEW

N/A.

OBJECTIVES

By the end of this lesson the cadet shall be expected to describe the production of lift by an aircraft wing.

IMPORTANCE

It is important for cadets to learn about the production of lift by an aircraft wing so that they can develop an understanding of subsequent and related principles of flight.

A-CR-CCP-802/PF-001

Teaching Point 1

Explain That Air Acts Like a Fluid

Time: 10 min

Method: In-Class Activity

AIR ACTS LIKE A FLUID

Air behaves like a fluid since it has pressure and speed. As airspeed increases, its pressure drops. A wing uses principle to deflect air, which causes an equal and opposite reaction.

The pressure of moving air can be examined by blowing gently over a small piece of curved paper. The air does not push the paper down as might be intuitively assumed. Instead, the paper behind the curve rises toward the moving air. This happens because the air pressure drops over the paper due to the air's increased speed—this would seem to match the description of speed/pressure relationship. The curvature in the paper enhances the effect of the lowered air pressure.



Distribute handout of [Figure 11D-2 – Creating Lift](#) located at the end of this document.

ACTIVITY

Time: 5 min

OBJECTIVE

The objective of this activity is to have the cadets reduce the air pressure over a sheet of paper and observe the results.

RESOURCES

- Paper 8 1/2 x 11, and
- Pencil.

ACTIVITY LAYOUT

N/A.

ACTIVITY INSTRUCTIONS

1. Tear a sheet of paper 8 1/2 x 11 vertically, into two pieces.
2. Curve one end of the sheet gently over a pencil as shown in [Figure 11D-2](#).
3. Blow gently over the paper as shown in [Figure 11D-2](#).
4. Observe that the paper rises into the moving air.

SAFETY

N/A.

A-CR-CCP-802/PF-001

CONFIRMATION OF TEACHING POINT 1

QUESTIONS

- Q1. Why does air behave like a fluid?
- Q2. Why does the paper airfoil rise when a cadet blows over it?
- Q3. Why was the paper deliberately curved before blowing over it?

ANTICIPATED ANSWERS

- A1. It has speed and pressure.
- A2. Air pressure over the paper drops as the air moves, so the still air below the paper pushes it up.
- A3. The curvature in the paper enhances the effect of the lowered air pressure.

END OF LESSON CONFIRMATION

The cadet's participation in the in-class activity will serve as the confirmation of this lesson.

CONCLUSION

HOMEWORK/READING/PRACTICE

N/A.

METHOD OF EVALUATION

N/A.

CLOSING STATEMENT

There are other methods of producing lift, such as rocketry, but airfoils are by far the most common, not just because of their elegance, but because they are best suited to prolonged horizontal flight.

INSTRUCTOR NOTES/REMARKS

N/A.

REFERENCES

- C3-017 (ISBN 1-895569-23-0) Schmidt, N. (1998). *Fabulous Paper Gliders*. New York, NY: Sterling Publishing.
- C3-116 A-CR-CCP-263/PT-001/(ISBN 0-9680390-5-7) MacDonald, A. F. and Pepler, J. L. (2000). *From the Ground Up: Millennium Edition*. Ottawa, ON: Aviation Publishers Co. Limited.

CREATING LIFT

CREATING LIFT

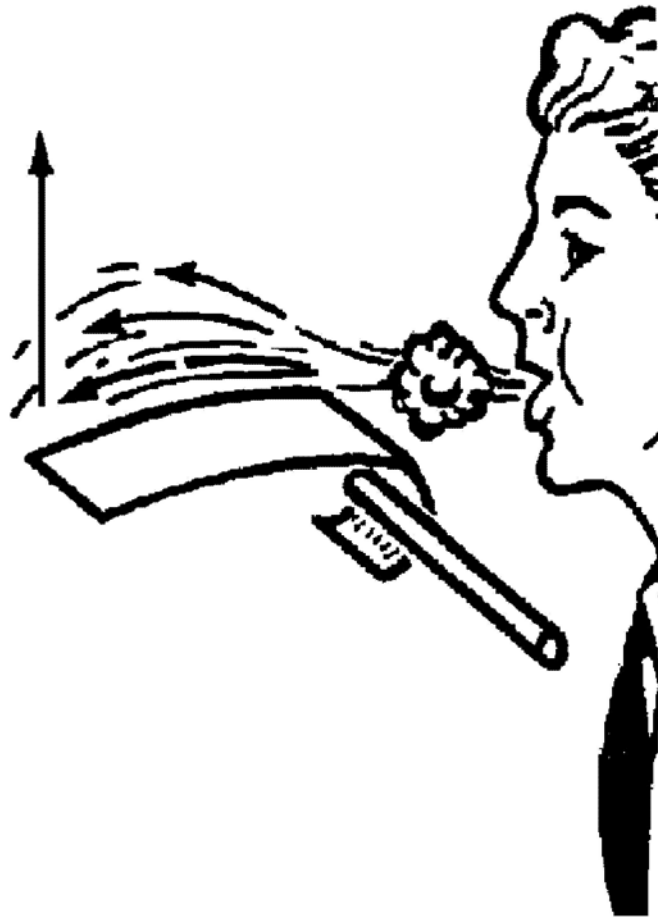

Cadets Canada: RCSU Pacific, 2007, Air Cadet Master Lesson Plans. Retrieved 7 March 2007, from http://www.regions.cadets.ca/pac/aircad/resources/mlp_air_e.asp

Figure 11D-2 Creating Lift

MODIFIED LESSON INSTRUCTIONS AND INSTRUCTIONAL GUIDES – TPs 1 AND 2 OF EO M231.04

A-CR-CCP-802/PG-001

EO M231.04 – DESCRIBE THE AXIAL MOVEMENTS OF AN AIRCRAFT

1. **Performance.** Describe the Axial Movements of an Aircraft.
2. **Conditions**
 - a. Given:
 - (1) Supervision; and
 - (2) Assistance as required.
 - b. Denied: N/A.
 - c. Environmental: Suitable classroom facilities or training area large enough to accommodate the entire group.
3. **Standard.** In accordance with specified references, the cadet shall describe the axial movements of an aircraft, to include:
 - a. the three axes of an aircraft; and
 - b. the three corresponding axial movements.

4. **Teaching Points**

TP	Description	Method	Time	Ref
TP1	Explain that aircraft operate in a three-dimensional space. Identify the three axes of aircraft movement, to include: <ol style="list-style-type: none"> a. the longitudinal axis; b. the lateral axis; and c. the vertical axis. 	Interactive Lecture	5 min	C3-116 (p. 30)
TP2	Using a model aircraft, describe the three movements that aircraft make around their three axes, to include: <ol style="list-style-type: none"> a. roll about the longitudinal axis; b. pitch about the lateral axis; and c. yaw about the vertical axis. 	Interactive Lecture	10 min	C3-116 (p. 30) C3-017 (p. 22)

5. **Time**
 - a. Introduction/Conclusion: 5 min
 - b. Interactive Lecture: 10 min
 - c. Total: 15 min
6. **Substantiation.** An interactive lecture was chosen for this lesson to introduce the subject of axial movement of an aircraft and give an overview of it.

7. **References**

- a. C3-017 (ISBN 1-895569-23-0) Schmidt, N. (1998). *Fabulous Paper Gliders*. New York, NY: Sterling Publishing.
- b. C3-116 A-CR-CCP-263/PT-001 (ISBN 0-9680390-5-7) MacDonald, A. F. and Pepler, I. L. (2000). *From the Ground Up: Millennium Edition*. Ottawa, ON: Aviation Publishers Co. Limited.

8. **Training Aids**

- a. Presentation aids (e.g. whiteboard/flipchart/OHP/multimedia projector) appropriate for the classroom/training area; and
- b. Model of a light fixed-wing aircraft with wing struts, fixed gear and control surface detail.

9. **Learning Aids.** N/A.

10. **Test Details.** N/A.

11. **Remarks.** N/A.



ROYAL CANADIAN AIR CADETS
PROFICIENCY LEVEL TWO
INSTRUCTIONAL GUIDE



SECTION 4

EO M231.04 – DESCRIBE THE AXIAL MOVEMENTS OF AN AIRCRAFT

Total Time: 15 min

PREPARATION

PRE-LESSON INSTRUCTIONS

Resources needed for the delivery of this lesson are listed in the lesson specification located in A-CR-CCP-802/PG-001, Chapter 4. Specific uses for said resources are identified throughout the Instructional Guide within the TP for which they are required.

Review the lesson content and become familiar with the material prior to delivering the lesson.

Photocopy handouts of [Figure 11K-1](#) Axes of an Aircraft for each cadet, located at the end of this document.

Obtain a model of a light fixed-wing aircraft with wing struts, fixed gear and control surface detail.

PRE-LESSON ASSIGNMENT

N/A.

APPROACH

An interactive lecture was chosen for this lesson to introduce the subject of axial movement and give an overview of it.

INTRODUCTION

REVIEW

N/A.

OBJECTIVES

By the end of this lesson the cadet shall be expected to identify the three axes of an aircraft and describe an aircraft's movement about them.

IMPORTANCE

It is important for cadets to learn about aircraft axes and axial movement so that they can understand subsequent and related principles of flight.

A-CR-CCP-802/PF-001

Teaching Point 1

Identify the Three Axes of Aircraft Movement

Time: 5 min

Method: Interactive Lecture

Aircraft operate in a three-dimensional space so there are three corresponding ways they can turn. Each of the three possibilities has an associated axis of motion:

- the longitudinal axis,
- the lateral axis, and
- the vertical axis.



Distribute handouts of aircraft axes in [Figure 11K-1 Axes of an Aircraft](#), located at the end of this document.

When an aircraft is airborne, it can move in almost any direction. All movement of the aircraft takes place around the centre of gravity. This is the aircraft's balance point, or point through which all weight acts downwards.



The centre of gravity is the point where the three axes intersect.

To clarify the ways that aircraft can move in flight, the aircraft is said to move around an axis. This is an imaginary line running through the centre of gravity of the aircraft and around which the aircraft rotates.

There are three such axes and the aircraft may rotate around one, two or all three axes at the same time. They are the longitudinal axis, the lateral axis, and the vertical axis:

- The longitudinal axis runs lengthwise through the fuselage from the nose to the tail and passes through the centre of gravity.
- The lateral axis runs from wingtip to wingtip through the centre of gravity.
- The vertical axis runs vertically through the centre of gravity. It is situated at right angles to the other axes.

CONFIRMATION OF TEACHING POINT 1

QUESTIONS

- Q1. Why does an aircraft have exactly three axes of motion?
- Q2. Where is an aircraft's centre of gravity located?
- Q3. What are the three axes of an aircraft called?

ANTICIPATED ANSWERS

- A1. An aircraft operates in a three-dimensional space and needs an axis for each dimension.
- A2. At the intersection of the three axes of motion.
- A3. The three axes of an aircraft are the longitudinal axis, the lateral axis and the vertical axis.

A-CR-CCP-802/PF-001

Teaching Point 2

Describe the Three Axial Movements That Aircraft Make

Time: 5 min

Method: Interactive Lecture



Using a model aircraft, describe the three movements that aircraft make around their three axes, to include:

- roll about the longitudinal axis;
- pitch about the lateral axis; and
- yaw about the vertical axis.

Have cadets simulate the three movements of an aircraft using their hand. Spin the wrist right to left to simulate roll, bend the wrist up and down to simulate pitch, and twist the wrist left to right simulate yaw.

Rolling. Movement of an aircraft about the longitudinal axis is called roll.

Pitching. Movement of an aircraft about the lateral axis is called pitch.

Yawing. Movement of an aircraft about the vertical axis is called yaw.

CONFIRMATION OF TEACHING POINT 2

QUESTIONS

- Q1. What is roll?
Q2. What is pitch?
Q3. What is yaw?

ANTICIPATED ANSWERS

- A1. Roll is the movement of an aircraft about its longitudinal axis.
A2. Pitch is the movement of an aircraft about its lateral axis.
A3. Yaw is the movement of an aircraft about its vertical axis.

END OF LESSON CONFIRMATION

Have the cadets simulate the movements of an aircraft using their hand as confirmation of this lesson.

CONCLUSION

HOMEWORK/READING/PRACTICE

N/A.

METHOD OF EVALUATION

N/A.

A-CR-CCP-802/PF-001

CLOSING STATEMENT

Movement through a three-dimensional space requires three axes of movement. The names of the axes and the names of the movements are borrowed from the sea, where ships have pitched, yawed and rolled for thousands of years.

INSTRUCTOR NOTES/REMARKS

N/A.

REFERENCES

- C3-017 (ISBN 1-895569-23-0) Schmidt, N. (1998). *Fabulous Paper Gliders*. New York, NY: Sterling Publishing.
- C3-116 A-CR-CCP-263/PT-001/(ISBN 0-9680390-5-7) MacDonald, A. F. and Peppler, I. L. (2000). *From the Ground Up: Millennium Edition*. Ottawa, ON: Aviation Publishers Co. Limited.

AXES OF AN AIRCRAFT
AXIAL MOVEMENTS

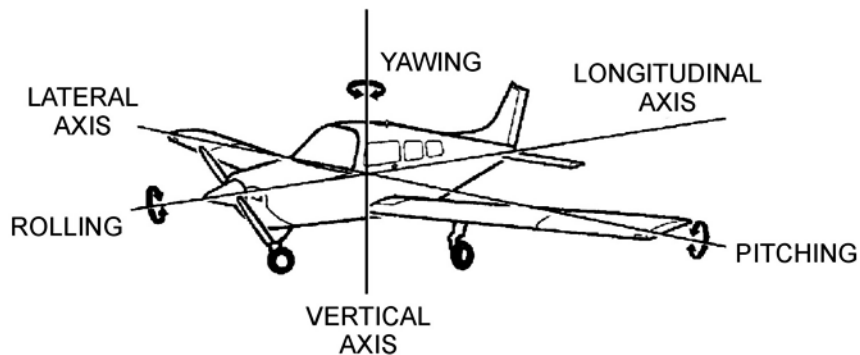

Cadets Canada: RCSU Pacific, 2007, Air Cadet Master Lesson Plans. Retrieved 7 March 2007, from http://www.regions.cadets.ca/pac/aircad/resources/mlp_air_e.asp

Figure 11K-1 Axes of an Aircraft

THIS PAGE INTENTIONALLY LEFT BLANK

MODIFIED LESSON INSTRUCTIONS AND INSTRUCTIONAL GUIDES – TP 1 OF EO M232.01

A-CR-CCP-802/PG-001

EO M232.01 – IDENTIFY TYPES OF AIRCRAFT ENGINES

1. **Performance.** Identify Types of Aircraft Engines.
2. **Conditions**
 - a. Given:
 - (1) Supervision; and
 - (2) Assistance as required.
 - b. Denied: N/A.
 - c. Environmental: Suitable classroom facilities or training area large enough to accommodate the entire group.
3. **Standard.** In accordance with specified references, the cadet shall identify types of aircraft engines, to include:
 - a. rocket engines;
 - b. gas turbine engines; and
 - c. piston-powered engines.

4. **Teaching Points**

TP	Description	Method	Time	Ref
TP1	Explain that a powered aircraft needs a means of propulsion to overcome drag and allow the wings to generate lift. Identify common engine types used for propulsion, to include: <ol style="list-style-type: none"> a. rocket engines; b. gas turbine jet engines; and c. piston-powered engines. 	Interactive Lecture	10 min	C3-116 (p. 51) C3-084 C3-086 C3-087 C3-088

5. **Time**
 - a. Introduction/Conclusion: 5 min
 - b. Interactive Lecture: 10 min
 - c. Total: 15 min
6. **Substantiation.** An interactive lecture was chosen for TP1 to introduce types of aircraft engines and give an overview of them.
7. **References**
 - a. C3-084 NASA Glenn Research Center. *Engines 101*. Retrieved 21 February 2007, from <http://www.ueet.nasa.gov/Engines101.html#Aeronautics>.
 - b. C3-086 NASA Glenn Research Center. *Engines 101*. Retrieved 21 February 2007, from <http://www.grc.nasa.gov/WWW/K-12/airplane/icengine.html>.

- c. C3-087 NASA Glenn Research Center. *Propulsion Index*. Retrieved 21 February 2007, from <http://www.grc.nasa.gov/WWW/K-12/airplane/shortp.html>.
 - d. C3-088 NASA *Welcome to the Beginner's Guide to Rockets*. Retrieved 21 February 2007, from <http://exploration.grc.nasa.gov/education/rocket/bgmr.html>.
 - e. C3-116 A-CR-CCP-263/PT-001/(ISBN 0-9680390-5-7) MacDonald, A. F. and Pepler, I. L. (2000). *From the Ground Up: Millennium Edition*. Ottawa, ON: Aviation Publishers Co. Limited.
- 8. **Training Aids.** Presentation aids (e.g. whiteboard/flipchart/OHP) appropriate for the classroom/training area.
 - 9. **Learning Aids.** N/A.
 - 10. **Test Details.** N/A.
 - 11. **Remarks.** N/A.

A-CR-CCP-802/PF-001



ROYAL CANADIAN AIR CADETS
PROFICIENCY LEVEL TWO
INSTRUCTIONAL GUIDE



SECTION 1

EO M232.01 – IDENTIFY TYPES OF AIRCRAFT ENGINES

Total Time: 15 min

PREPARATION

PRE-LESSON INSTRUCTIONS

Resources needed for the delivery of this lesson are listed in the lesson specification located in A-CR-CCP-802/PG-001, Chapter 4. Specific uses for said resources are identified throughout the Instructional Guide within the TP for which they are required.

Review the lesson content and become familiar with the material prior to delivering the lesson.

PRE-LESSON ASSIGNMENT

N/A.

APPROACH

An interactive lecture was chosen for TP1 to introduce types of aircraft engines and give an overview of them.

INTRODUCTION

REVIEW

N/A.

OBJECTIVES

By the end of this lesson the cadet shall be expected to identify types of aircraft engines.

IMPORTANCE

Engines are one of the key systems in a powered aircraft. It is important for cadets to learn about types of aircraft engines so that they can understand subsequent and related aspects of aviation.

Teaching Point 1

Explain That a Powered Aircraft Needs a Means of Propulsion

Time: 10 min

Method: Interactive Lecture

A powered aircraft needs a means of propulsion to overcome drag and allow the wings to generate sufficient lift to overcome weight.

A-CR-CCP-802/PF-001

The propeller and jet engine are very closely related, providing thrust by the same means – the acceleration of a mass of air. The propeller generates thrust by acting on a large mass of air, giving it a relatively small acceleration. The jet engine does exactly the same thing by giving a larger acceleration to a smaller mass of air.

The most common engine types used for aviation propulsion employ internal combustion and they include:

- rocket engines,
- gas turbine jet engines, and
- reciprocating piston-powered engines.



Show the cadets a slide or handout of rocket engine applications in [Figures 12A-1](#) and [12A-2](#).

The earliest vehicle engines were rocket engines used to power ancient Chinese fire arrows. This method of propulsion proved so effective that, with many improvements, it is still commonly used today for many applications including space exploration. Self-contained with their own oxidizer, rockets have the great advantage of being able to function in a vacuum such as outer space.



All propulsion systems are reactive, meaning that they all employ an equal and opposite reaction predicted by Newton's third law of motion.

Piston-powered internal combustion engines were developed in the late nineteenth century. They were available to Orville and Wilbur Wright, who designed their 1903 flyer with a four-cylinder piston-powered engine.



Show the cadets a slide or handout of a Harvard piston-powered engine application in [Figures 12A-3](#) and [12A-4](#) located at the end of this document.

Piston-powered engines are the most common vehicle engine of all and the one that Proficiency Level Two cadets will explore in most detail. In many ways, pistons are the most complicated system of converting the chemical energy of fuel into the energy of motion but they are found in many places, including aircraft, automobiles, boats and lawnmowers.



Show the cadets a slide or handout of a gas turbine jet engine application in [Figures 12A-5](#) and [12A-6](#) located at the end of this document. Point out the airflow path and combustion location in the schematic.

Gas turbine jet engines are improvements upon simple ramjets. The ramjet is a liquid-fuelled rocket-like engine, which uses atmospheric oxygen to burn fuel. One of the most limiting aspects of a ramjet is that it requires high velocity to work. Therefore it cannot start combustion until it is up to speed – it must be launched from a speeding vehicle. Air-launched missiles are one of the few applications of ramjet engines.

Any turbine converts the energy of moving liquid or gases, such as jet exhaust or wind, into rotary motion to turn a shaft. A windmill is a turbine which uses wind energy to turn a shaft. Among other advantages, adding

A-CR-CCP-802/PF-001

a turbine to the simple ramjet allows a compressor to generate high-pressure air so that the gas turbine jet engine can be started from a resting, or static, position. This is the secret of the modern gas turbine jet engine, which still relies on the ejection of hot gases to produce thrust. Until the turbine and compressor are functioning and delivering high-pressure air to the engine, however, the engine cannot start. Even gas turbine jet engines, therefore, must be started with a starting motor.



Show the cadets a slide or handout of the CT-114 Tutor turbojet engine application [Figures 12A-7](#) and [12A-8](#) located at the end of this document.

A gas turbine jet engine that provides thrust, with no rotating shaft output, is a TURBOJET engine.



Show the cadets a slide or handouts of the C-130 Hercules turboprop engine application [Figures 12A-9](#) and [12A-10](#) located at the end of this document.

A gas turbine jet engine that provides thrust and also drives a propeller is a TURBOPROP engine.



Show the cadets a slide or handout of the CH-146 Griffon turboshaft engine application [Figures 12A-11](#) and [12A-12](#) located at the end of this document.

A gas turbine engine that drives a helicopter rotor is usually a TURBOSHAFT engine. In a turboshaft helicopter engine, the output driveshaft is separate from the compressor turbine shaft so that engine speed is not tied to the helicopter's main rotor speed.



Show the cadets a slide or handout of the CC-150 Polaris (A310-300 Airbus) turbofan engine application [Figures 12A-5](#) and [12A-6](#) located at the end of this document. Point out the fan location.

The most common variation of the gas turbine jet engine is the TURBOFAN, which is a hybrid of a turbojet and a turboprop. The turbofan has a fan that provides thrust with bypass air, in place of a propeller, adding to the reactive thrust of the ejected exhaust gases. This application allows the aircraft to go faster than normal propellers could go, while also reducing engine noise and allowing the aircraft to make efficient use of fuel. The noise reduction and fuel efficiency of turbofans make them very effective for commercial aviation.



All three of these engine types, rocket, gas turbine jet and piston-powered engines, use internal combustion to capture the energy of expanding hot gases in a closed container.

END OF LESSON CONFIRMATION

QUESTIONS

Q1. Which engine type was the first to be used for propulsion?

A-CR-CCP-802/PF-001

Q2. Why are the rocket, gas-turbine and piston-powered engines all internal combustion engines?

Q3. Why does a gas turbine jet engine need to have a starting motor?

ANTICIPATED ANSWERS

A1. The rocket was the first to be used for propulsion.

A2. The rocket, gas-turbine and piston-powered engines all use internal combustion to capture the energy of hot expanding gases in a closed container.

A3. A gas turbine jet engine needs to have a starting motor because, until the turbine and compressor are running, there is no high-pressure air to operate the engine.

CONCLUSION

HOMEWORK/READING/PRACTICE

N/A.

METHOD OF EVALUATION

N/A.

CLOSING STATEMENT

The topic of aircraft engines is very broad and ever-changing as new solutions are found and new products developed to push the performance envelope.

INSTRUCTOR NOTES/REMARKS

N/A.

REFERENCES

C3-084 NASA Glenn Research Center. *Engines 101*. Retrieved 21 February 2007, from <http://www.ueet.nasa.gov/Engines101.html#Aeronautics>.

C3-086 NASA Glenn Research Center. *Engines 101*. Retrieved 21 February 2007, from <http://www.grc.nasa.gov/WWW/K-12/airplane/icengine.html>.

C3-087 NASA Glenn Research Center. *Propulsion Index*. Retrieved 21 February 2007, from <http://www.grc.nasa.gov/WWW/K-12/airplane/shortp.html>.

C3-088 NASA. *Welcome to the Beginner's Guide to Rockets*. Retrieved 21 February 2007, from <http://exploration.grc.nasa.gov/education/rocket/bgmr.html>.

C3-116 A-CR-CCP-263/PT-001/(ISBN 0-9680390-5-7) MacDonald, A. F. and Pepler, I. L. (2000). *From the Ground Up: Millennium Edition*. Ottawa, ON: Aviation Publishers Co. Limited.

IDENTIFYING TYPES OF AIRCRAFT ENGINES

Rocket Engines



National Aeronautics and Space Administration (NASA), "Missions" Space Shuttle System (2006). Retrieved 17 March 2007, from http://www.nasa.gov/returntoflight/system/system_SSME.html

Figure 12A-1 Rocket Engine Application

	ROCKET PROPULSION	GLENN RESEARCH CENTER

NASA Glenn Research Center. "Propulsion Index". *Rocket Propulsion* (2006). Retrieved 21 February 2007, from <http://www.grc.nasa.gov/WWW/K-12/airplane/shortp.html>

Figure 12A-2 X-15 in Flight

A-CR-CCP-802/PF-001
Chapter 12, Annex A

Piston-powered Engines



Canadian Forces. Aircraft. (2005). Retrieved 17 March 2007, from http://www.airforce.gc.ca/equip/equip1_e.asp

Figure 12A-3 Piston-powered Engine Application

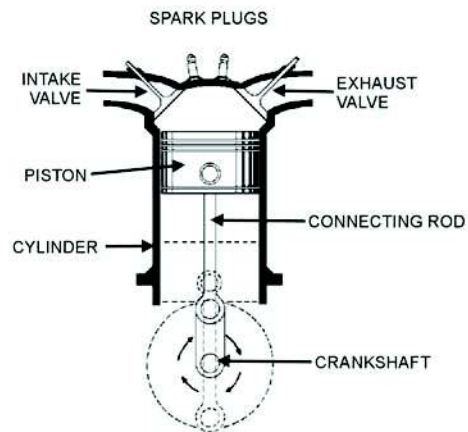

A-CR-CCP-263/PT-001 (p. 53)

Figure 12A-4 Piston-powered Engine Schematic

Jet Engine



Canadian Forces. Aircraft. (2005). Retrieved 17 March 2007, from http://www.airforce.gc.ca/equip/equip1_e.asp

Figure 12A-5 Gas Turbine Engine Application

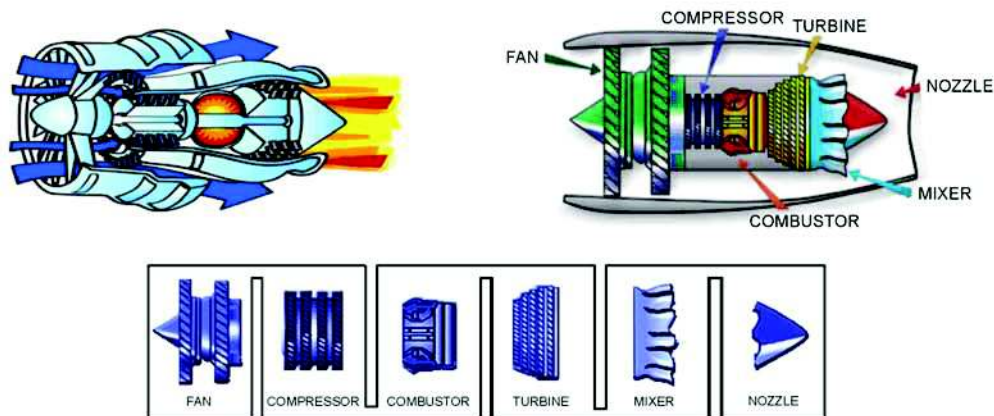

NASA "Engines 101". Ultra Efficient Engine Technology (UEET). (2001). Retrieved 17 March 2007, from <http://www.ueet.nasa.gov/Engines101.html>

Figure 12A-6 Turbofan Parts

A-CR-CCP-802/PF-001
Chapter 12, Annex A

Turbojet Engines



Canadian Forces. Aircraft. (2005). Retrieved 17 March 2007, from http://www.airforce.gc.ca/equip/equip1_e.asp

Figure 12A-7 Turbojet Application

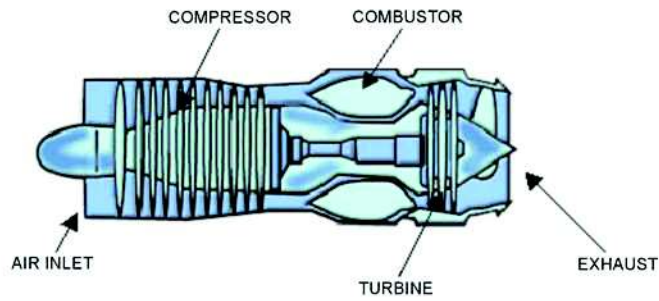

NASA Engines 101. Ultra Efficient Engine Technology (UEET). (2001). Retrieved 17 March 2007, from <http://www.ueet.nasa.gov/Engines101.html>

Figure 12A-8 Turbojet Schematic

Turboprop Engines



Canadian Forces. Aircraft. (2005). Retrieved 17 March 2007, from http://www.airforce.gc.ca/equip/equip1_e.asp

Figure 12A-9 Turboprop Application

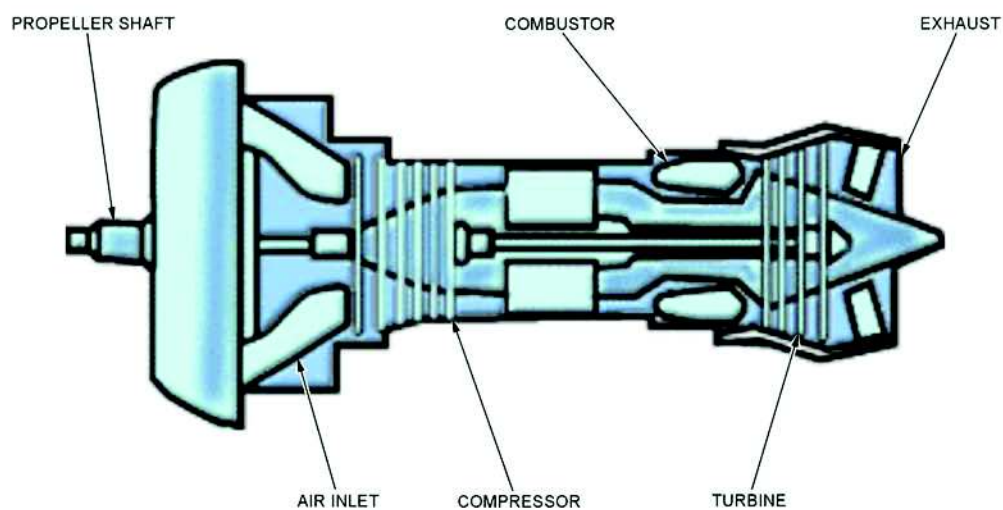

NASA Engines 101. Ultra Efficient Engine Technology (UEET). (2001). Retrieved 17 March 2007, from <http://www.ueet.nasa.gov/Engines101.html>

Figure 12A-10 Turboprop Engine Schematic

A-CR-CCP-802/PF-001
Chapter 12, Annex A

Turboshaft Engines



Canadian Forces. Aircraft. (2005). Retrieved 17 March 2007, from http://www.airforce.gc.ca/equip/equip1_e.asp

Figure 12A-11 Turboshaft Engine Application

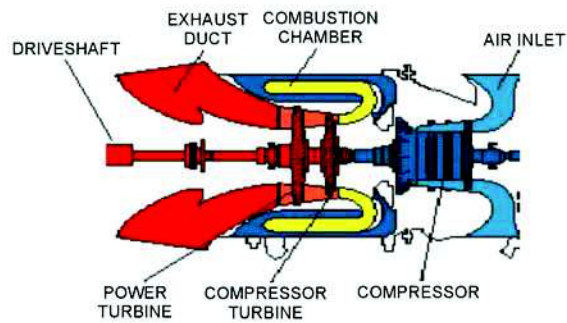

Imagine the Power, Pratt & Whitney Canada. Retrieved 16 March 2007, from http://www.pwc.ca/en/3_0/3_0_3/3_0_3_3_1.asp

Figure 12A-12 Turboshaft Engine Schematic

MODIFIED LESSON INSTRUCTIONS AND INSTRUCTIONAL GUIDES – TP 2 OF EO C232.03

A-CR-CCP-802/PF-001

EO C232.03 – IDENTIFY THE CHARACTERISTICS OF HELICOPTER ENGINES

1. **Performance.** Identify the Characteristics of Helicopter Engines.
2. **Conditions**
 - a. Given:
 - (1) Supervision; and
 - (2) Assistance as required.
 - b. Denied: N/A.
 - c. Environmental: Suitable classroom facilities or training area large enough to accommodate the entire group.
3. **Standard.** The cadet shall identify the characteristics of helicopter engines, to include:
 - a. technical development of early helicopter engines;
 - b. challenges of rotary-wing flight; and
 - c. categories of engines in CF helicopters.

4. **Teaching Points**

TP	Description	Method	Time	Ref
TP1	Have the cadets make and fly a paper helicopter.	In-Class Activity	10 min	C3-056

5. **Time**
 - a. Introduction/Conclusion: 5 min
 - b. In-class Activity: 10 min
 - c. Total: 15 min
6. **Substantiation.** An in-class activity was chosen for TP1 as it is an interactive way to provoke thought and stimulate interest among cadets.
7. **References.** C3-056 US Centennial of Flight Commission. *Helicopters*. (2003). Retrieved 12 October 2006, from <http://www.centennialofflight.gov/essay/Dictionary/helicopter/DI27.htm>.
8. **Training Aids**
 - a. Presentation aids (e.g. whiteboard/flipchart/OHP/multimedia projector) appropriate for the classroom/training area;
 - b. Completed paper helicopter for demonstration purposes;
9. **Learning Aids**
 - a. Directions to construct and fold a paper helicopter (A-CR-CCP-802/PF-001, Annex D); and
 - b. Materials required to construct a paper helicopter.
10. **Test Details.** N/A.



ROYAL CANADIAN AIR CADETS
PROFICIENCY LEVEL TWO
INSTRUCTIONAL GUIDE



SECTION 7

EO C232.03 – IDENTIFY THE CHARACTERISTICS OF HELICOPTER ENGINES

Total Time: 15 min

PREPARATION

PRE-LESSON INSTRUCTIONS

Resources needed for the delivery of this lesson are listed in the lesson specification located in A-CR-CCP-802/PG-001, Chapter 4. Specific uses for said resources are identified throughout the Instructional Guide within the TP for which they are required.

Review the lesson content and become familiar with the material prior to delivering the lesson.

Photocopy handouts of the paper helicopter construction templates and instructions shown in [Figures 12T-2](#) and [12T-3](#) for each cadet.

Gather materials needed for the construction of the paper helicopter.

PRE-LESSON ASSIGNMENT

N/A.

APPROACH

An in-class activity was chosen for TP1 as it is an interactive way to provoke thought and stimulate an interest among cadets.

INTRODUCTION

REVIEW

N/A.

OBJECTIVES

By the end of this lesson the cadet shall identify the characteristics of helicopter engines.

IMPORTANCE

It is important for cadets to know about the characteristics of helicopter engines because helicopters form a significant part of the Canadian Forces' lift, tactical manoeuvring and Search and Rescue capabilities.

A-CR-CCP-802/PF-001

Teaching Point 1

Make and Fly a Paper Helicopter

Time: 10 min

Method: In-Class Activity

When a helicopter engine loses power under flight, the pilot can auto-rotate the aircraft to the ground.

Auto-rotation is the state of flight where the main rotor is being turned by the action of the wind passing up through the rotor disc instead of being turned by engine power.

ACTIVITY

Time: 15 min

OBJECTIVE

The objective of this activity is to have the cadets fold paper helicopters and then auto-rotate them to the ground to demonstrate that loss of engine power does not necessarily lead to a crash.

RESOURCES

Instructions and the template for folding a paper helicopter shown in [Figures 12T-2](#) and [12T-3](#).

ACTIVITY LAYOUT

N/A.

ACTIVITY INSTRUCTIONS

1. Distribute the instructions and template for paper helicopter construction to each cadet.
2. Have the cadets cut out the paper helicopter and then fold it into shape.
3. Have the cadets stand and drop the helicopters.



Give the paper helicopter a spin before releasing it. This will help establish effective rotor action because, as stated by Newton's first law of motion, every object in a state of uniform motion tends to remain in that state of motion unless an external force is applied to it.

SAFETY

N/A.

CONFIRMATION OF TEACHING POINT 1

The cadets' participation in the activity will serve as the confirmation of this TP.

END OF LESSON CONFIRMATION

The cadets' participation in the activity will serve as the confirmation of this lesson.

CONCLUSION

HOMEWORK/READING/PRACTICE

N/A.

METHOD OF EVALUATION

N/A.

CLOSING STATEMENT

Rotary wing aircraft present special challenges for aviation but they offer special capabilities as well, which enable them to make important contributions to the Canadian Forces' lift, tactical manoeuvring and Search and Rescue operations.

INSTRUCTOR NOTES/REMARKS

N/A.

REFERENCES

C3-056 US Centennial of Flight Commission. *Helicopters. (2003)*. Retrieved 12 October 2006, from <http://www.centennialofflight.gov/essay/Dictionary/helicopter/DI27.htm>.

INSTRUCTIONS AND TEMPLATE FOR FOLDING A PAPER HELICOPTER

MAKE A HELICOPTER

AIM: TO MAKE A TWIRLING HELICOPTER.

YOU WILL NEED: A HELICOPTER SHEET, SCISSORS, COLOURING PENCILS, PAPER CLIPS FOR WEIGHTS

WHAT TO DO:

1. COLOUR THE HELICOPTER SHEET.
2. CUT ALONG THE DOTTED LINES.
3. FOLD CORNERS A AND B TO MEET THE CENTRE LINE
4. FOLD E AND F IN THE OPPOSITE DIRECTIONS.

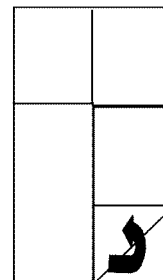
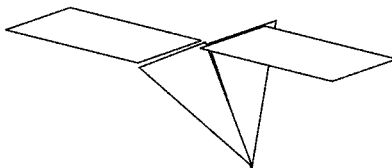

5. TEST YOUR HELICOPTER BY DROPPING IT FROM A HIGH PLACE (E.G. STANDING ON A RAISED PLATFORM).
6. DISCUSS WHAT HAPPENS.

THINGS TO TRY

DOES THE WAY THE FLAPS ARE BENT MAKE A DIFFERENCE TO THE HELICOPTER'S FALL?

ADD EXTRA WEIGHT TO YOUR HELICOPTER. DOES THIS MAKE A DIFFERENCE.

MAKE A NEW HELICOPTER WITH LONGER BLADES. HOW DOES IT WORK?

"Force and Movement" Making a Helicopter. Retrieved 11 October 2006, from http://www.teacherresourcesgalore.com/physics_files/helicopter.doc

Figure 12T-2 Instructions for Paper Helicopter Construction

PAPER HELICOPTER TEMPLATE

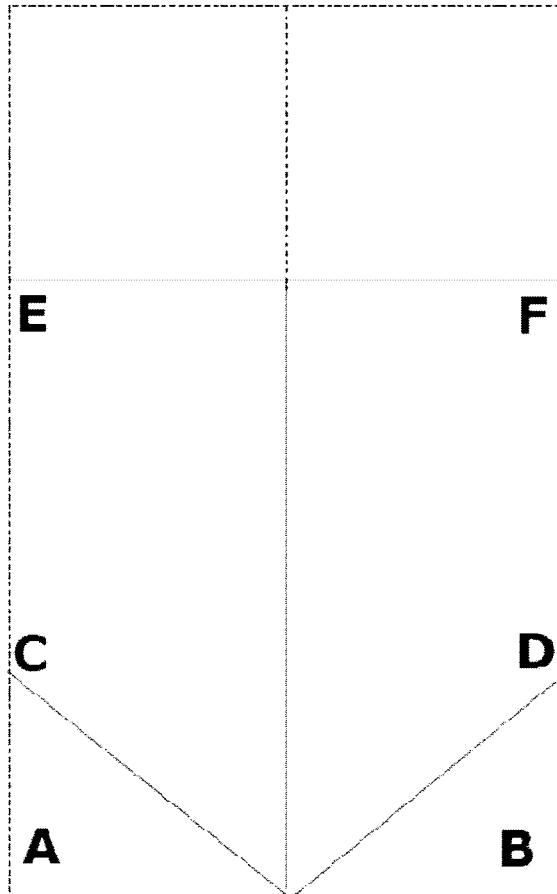

"Force and Movement: Making a Helicopter". Retrieved 11 October 2006, from http://www.teacherresourcesgalore.com/physics_files/helicopter.doc

Figure 12T-3 Template for Paper Helicopter Construction

MODIFIED LESSON INSTRUCTIONS AND INSTRUCTIONAL GUIDES – TP 2 OF EO C240.03

A-CR-CCP-802/PG-001

EO C240.03 – IDENTIFY PARTS OF A ROCKET

1. **Performance.** Identify Parts of a Rocket.
2. **Conditions**
 - a. Given:
 - (1) Supervision; and
 - (2) Assistance as required.
 - b. Denied: N/A.
 - c. Environmental: Suitable classroom facilities or training area large enough to accommodate the entire group.
3. **Standard.** In accordance with *Rocket Parts*, the cadet shall identify parts of a rocket to become familiar with its components.

4. **Teaching Points**

TP	Description	Method	Time	Ref
TP1	Conduct an activity naming the parts of a rocket.	In-class Activity	10 min	C3-106

5. **Time**
 - a. Introduction/Conclusion: 5 min
 - b. In-class Activity: 10 min
 - c. Total: 15 min
6. **Substantiation.** An in-class activity was chosen for TP1 as it is an interactive way to confirm the cadet's comprehension of the material.
7. **References.** C3-106 NASA. (2006). *Rocket Parts*. Retrieved 22 February 2007, from <http://exploration.grc.nasa.gov/education/rocket/rockpart.html#>.
8. **Training Aids.** Presentation aids (e.g. whiteboard/flipchart/OHP/multimedia projector) appropriate for the classroom/training area.
9. **Learning Aids**
 - a. Rocket parts puzzle; and
 - b. Parts of a rocket handout.
10. **Test Details.** N/A.
11. **Remarks.** N/A.



ROYAL CANADIAN AIR CADETS
PROFICIENCY LEVEL TWO
INSTRUCTIONAL GUIDE



SECTION 6

EO C240.03 – IDENTIFY PARTS OF A ROCKET

Total Time: 15 min

PREPARATION

PRE-LESSON INSTRUCTIONS

Resources needed for the delivery of this lesson are listed in the lesson specification located in A-CR-CCP-802/PG-001, Chapter 4. Specific uses for said resources are identified throughout the Instructional Guide within the TP for which they are required.

Review the lesson content and become familiar with the material prior to delivering the lesson.

Photocopy the handout located at [Figure 13F-1](#) for each cadet.

Photocopy and cut out the rocket puzzle pieces from [Figure 13G-1](#) through [Figure 13G-13](#) located at the end of this document.

PRE-LESSON ASSIGNMENT

N/A.

APPROACH

An in-class activity was chosen for TP1 as it is an interactive way to confirm the cadet's comprehension of the material.

INTRODUCTION

REVIEW

N/A.

OBJECTIVES

By the end of this lesson the cadet shall be expected to identify parts of a rocket to become familiar with its components.

IMPORTANCE

It is important for cadets to know the parts of a rocket so that they can understand how they are constructed. Identifying the parts of a rocket may develop an interest in the components that make up a rocket, which may lead to future aerospace opportunities in the Air Cadet Program.

A-CR-CCP-802/PF-001

Teaching Point 1

Conduct an Activity Naming the Parts of a Rocket

Time: 10 min

Method: In-class Activity



The following activity is designed to be done as a class activity. The class will construct and label the puzzle together, one piece at a time.

ACTIVITY

OBJECTIVE

The objective of this activity is to help cadets become familiar with the parts of a rocket.

RESOURCES

- The puzzle located at [Figure 13G-1](#) through [Figure 13G-13](#), and
- Tape.

ACTIVITY LAYOUT

N/A.

ACTIVITY INSTRUCTIONS

1. Provide the cadets with the puzzle parts and shapes of a rocket.
2. Request a cadet to volunteer and select a shape and place it on the board in front of the class.
3. Repeat the steps until all the shapes are up on the board and the rocket is built. Then repeat the steps using the words and pictures to label the rocket.



Allow cadets to make corrections if the parts of the puzzle are in the wrong place.

4. Use the handout located at [Annex F](#) as a guide to confirm if the puzzle is correct.

SAFETY

N/A.

CONFIRMATION OF TEACHING POINT 1

The cadets' participation in the parts of a rocket activity will serve as the confirmation of this TP.

END OF LESSON CONFIRMATION



Distribute [Figure 13F-1](#) Parts of a Rocket to each cadet.

The cadets' participation in identifying the parts of a rocket will serve as the confirmation of this lesson.

CONCLUSION

HOMEWORK/READING/PRACTICE

N/A.

METHOD OF EVALUATION

N/A.

CLOSING STATEMENT

Knowing the parts of a rocket will help cadets understand how rockets are constructed. Identifying the parts of a rocket will help cadets understand the components that make up the rocket, which may develop an interest in rocket technology that may lead to future aerospace opportunities in the Air Cadet Program.

INSTRUCTOR NOTES/REMARKS

N/A.

REFERENCES

C3-106 NASA. (2006). *Rocket Parts*. Retrieved 22 February 2007, from <http://exploration.grc.nasa.gov/education/rocket/rockpart.html#>.

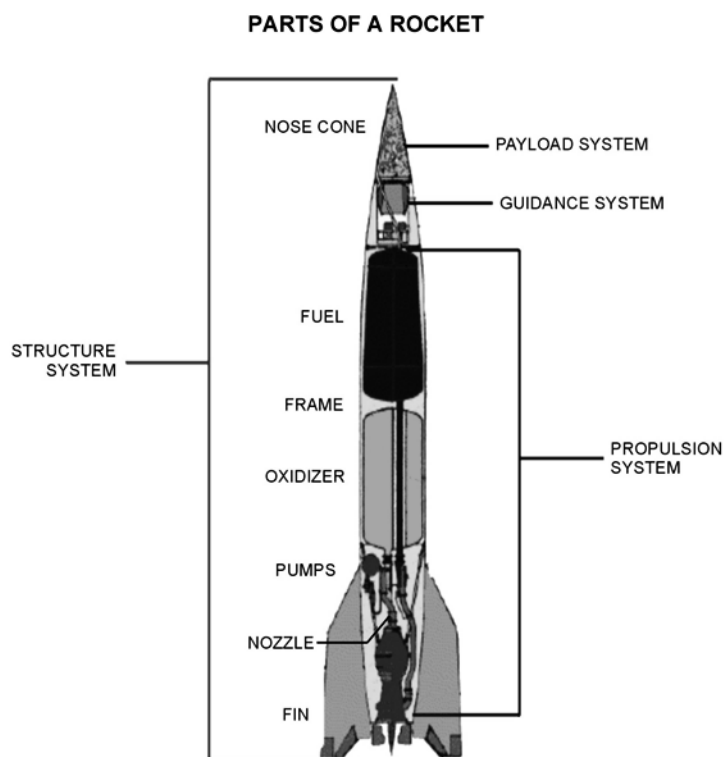

"NASA", *Parts of a Rocket*. Retrieved 23 April 2007, from <http://exploration.grc.nasa.gov/education/rocketpart.html#>

Figure 13F-1 Parts of a Rocket

ROCKET PUZZLE PIECES

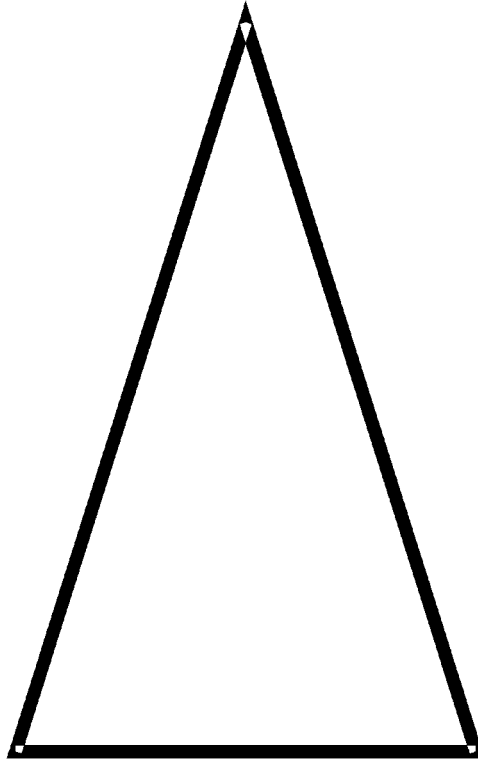

Director Cadets 3, 2006, Ottawa, ON: Department of National Defence

Figure 13G-1 Nose Cone (Part A)

A-CR-CCP-802/PF-001
Chapter 13, Annex G

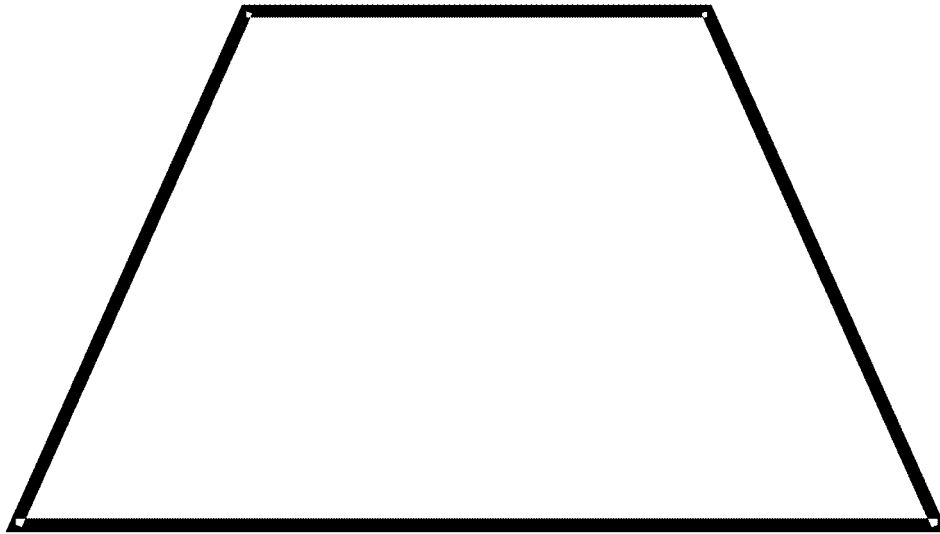

Director Cadets 3, 2006, Ottawa, ON: Department of National Defence

Figure 13G-2 Nose Cone (Part B)

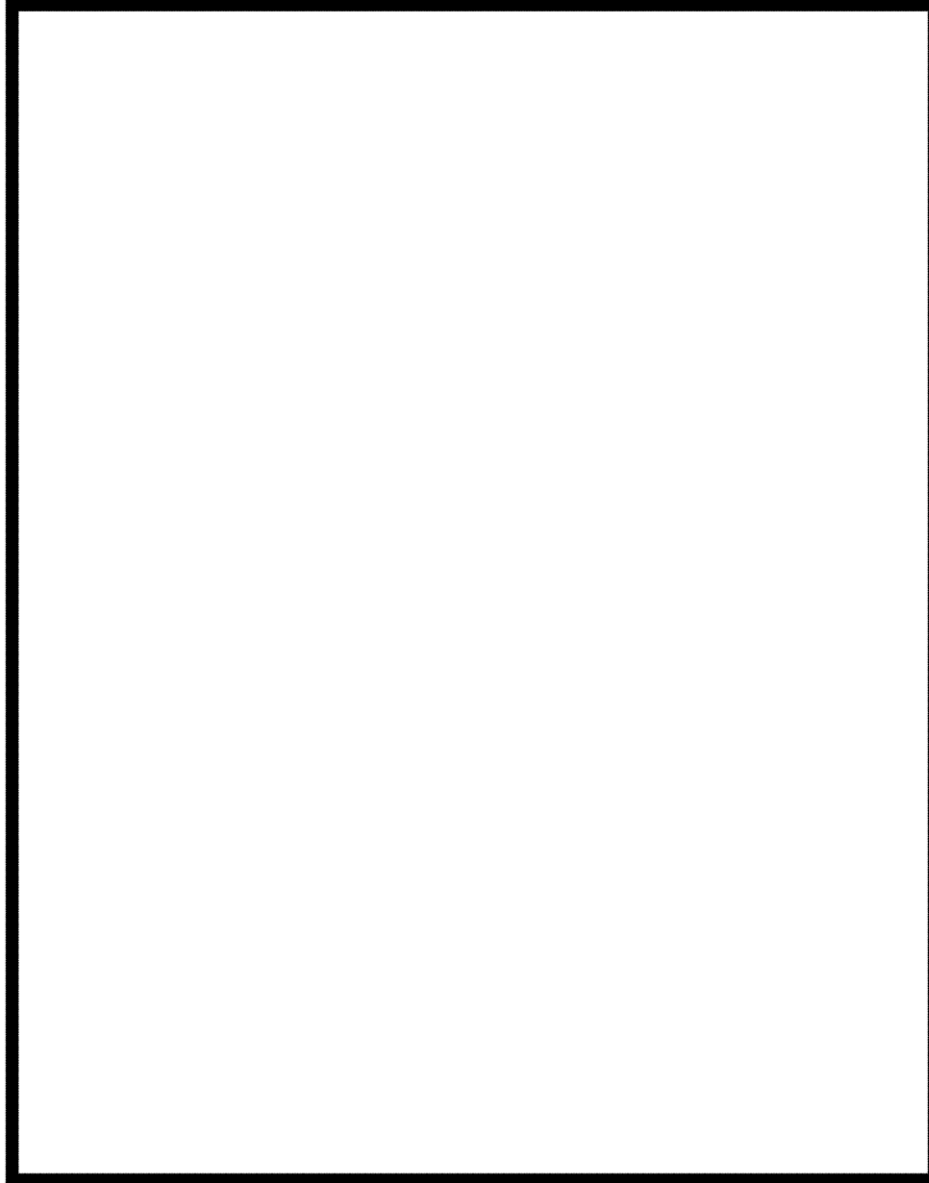

Director Cadets 3, 2006, Ottawa, ON: Department of National Defence

Figure 13G-3 Frame (Fuel Section)

A-CR-CCP-802/PF-001
Chapter 13, Annex G

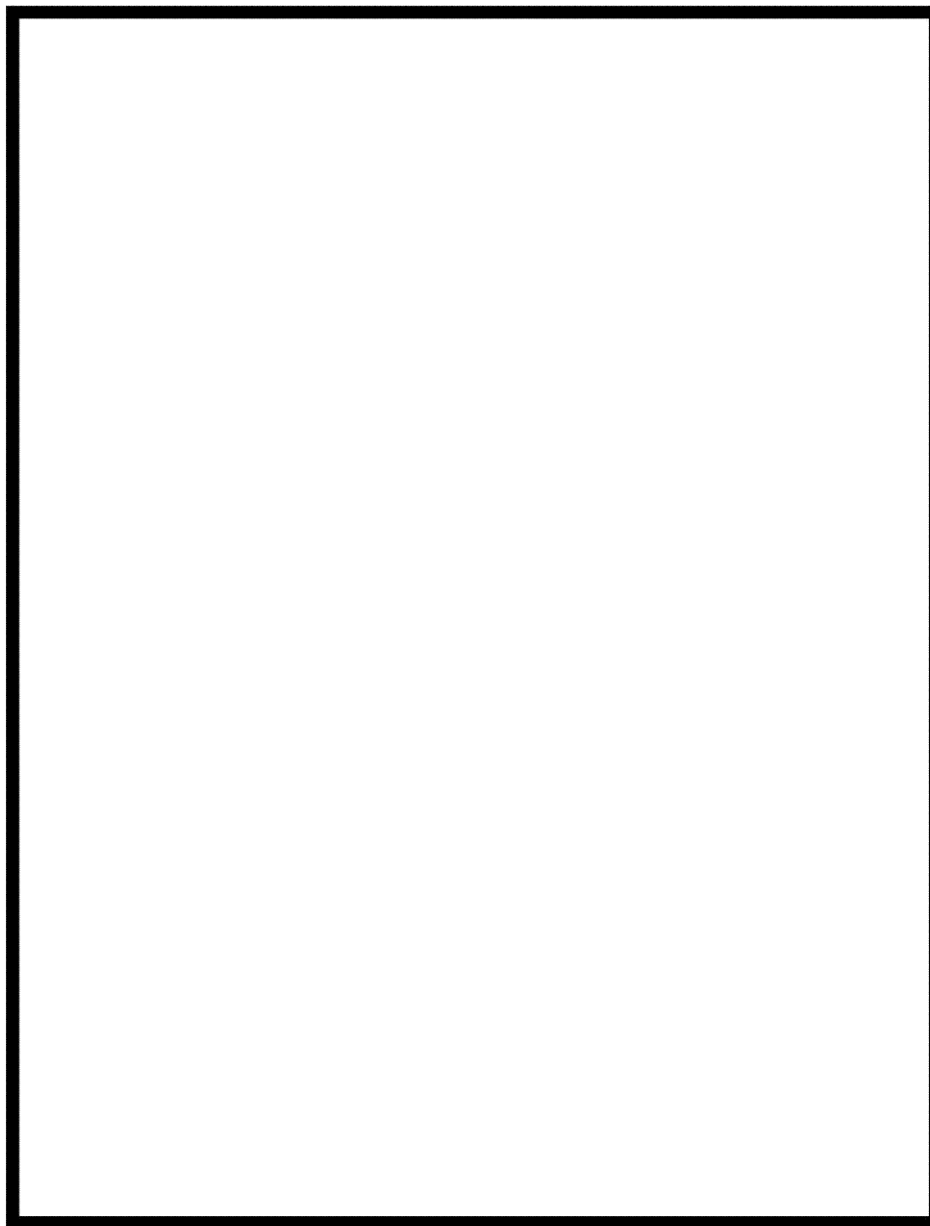

Director Cadets 3, 2006, Ottawa, ON: Department of National Defence

Figure 13G-4 Frame (Oxidizer Section)

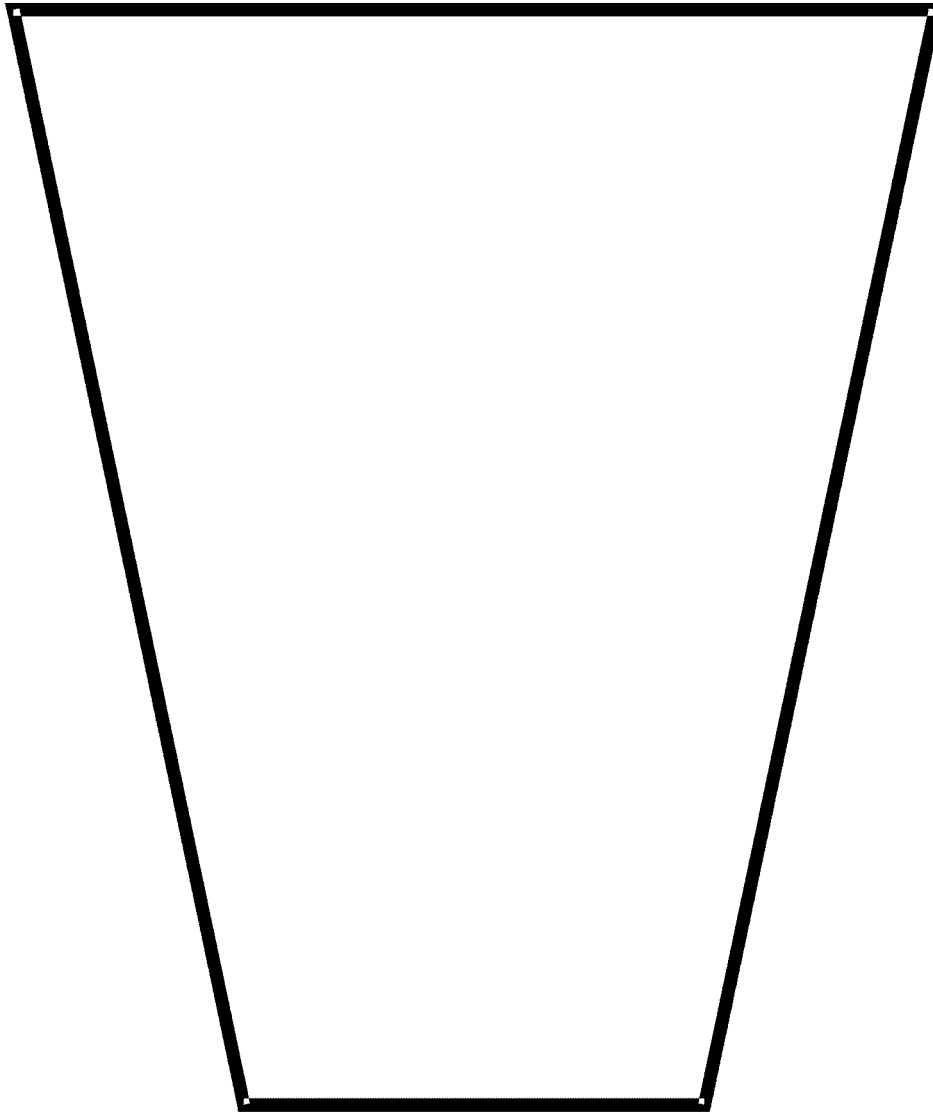

Director Cadets 3, 2006, Ottawa, ON: Department of National Defence

Figure 13G-5 Frame (Pumps and Nozzle Section 0)

A-CR-CCP-802/PF-001
Chapter 13, Annex G

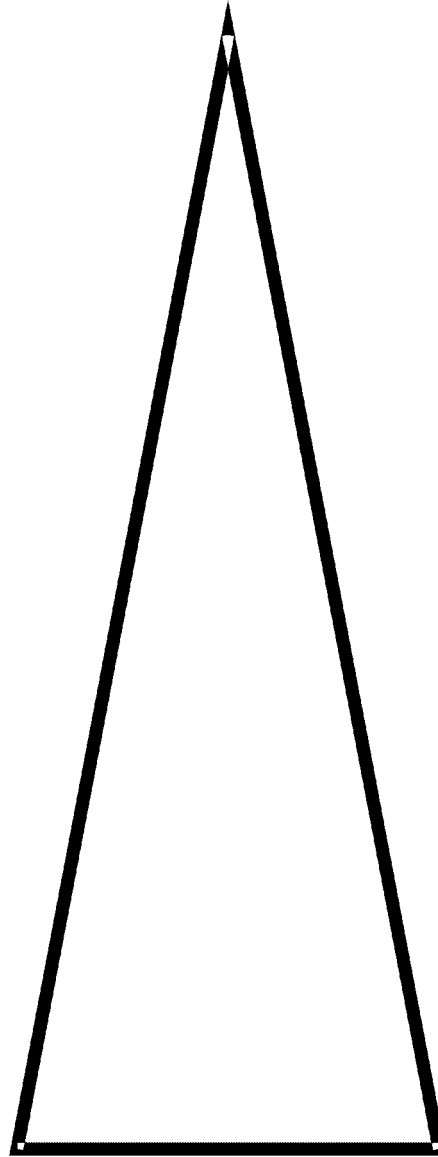

Director Cadets 3, 2006, Ottawa, ON: Department of National Defence

Figure 13G-6 Fin (Section 1)

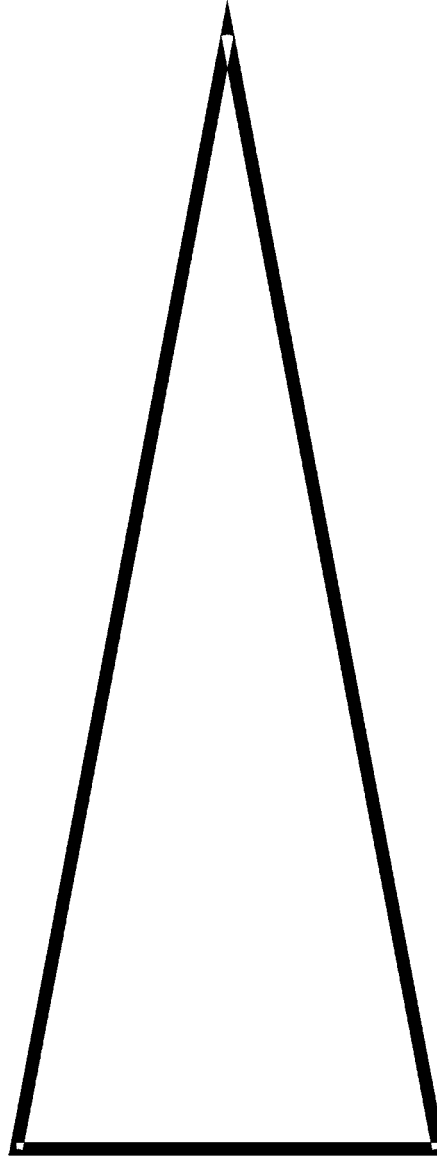

Director Cadets 3, 2006, Ottawa, ON: Department of National Defence

Figure 13G-7 Fin (Section 2)

A-CR-CCP-802/PF-001
Chapter 13, Annex G

PARTS OF A ROCKET: LABELS



Cut out the following boxes and figures to be used to label the rocket puzzle.

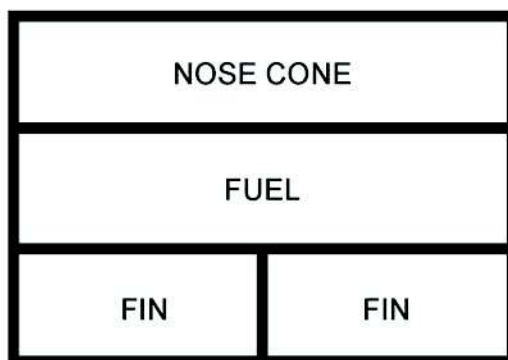

Director Cadets 3, 2006, Ottawa, ON: Department of National Defence

Figure 13G-8 Rocket Labels



GUIDANCE SYSTEM

"Clip Art", Microsoft Corporation, 2003, Santa Rosa: CA: Impresa Systems, Copyright 2000, Impresa Systems

Figure 13G-9 Guidance System



PAYLOAD SYSTEM

"Clip Art", Microsoft Corporation, 2003, Santa Rosa: CA: Impresa Systems, Copyright 2000, Impresa Systems

Figure 13G-10 Payload

A-CR-CCP-802/PF-001
Chapter 13, Annex G



FUEL PUMP

"Google Images", New Philadelphia, Ohio, Fuel Pump. Retrieved 18 April 2007, from <http://www.neohiotravel.com/images/gaspump.gif>

Figure 13G-11 Fuel Pump



OXIDIZER

"Google Images", California State University, Oxidizer Label. Retrieved 18 April 2007, from <http://www.csudh.edu/oliver/chemdata/wamlabs/oxidizer.jpg>

Figure 13G-12 Oxidizer



NOZZLE

*"Google Images", Airwork Aviation Images, Engines. Retrieved 18 April 2007,
from <http://www.airwork-images.com/details.php?gid=278&sgid=&pid=456>*

Figure 13G-13 Nozzle

INSTRUCTIONAL TECHNIQUES – ASSESSMENT FORM

Cadet's Name: _____

Flight: _____

Lesson Topic: _____

CRITERIA	COMMENTS	Incomplete	Completed With Difficulty	Completed Without Difficulty
PREPARATION				
Selected a lesson location.				
Set up the lesson location.				
Used a lesson plan.				
Selected an appropriate method(s) of instruction.				
Reviewed previous lesson material.				
INTRODUCTION				
Stated what the cadets will learn.				
Stated why it is important.				
Described where the knowledge/skill will be applied.				
BODY				
Applied the principles of instruction. (interest, comprehension, emphasis, participation, accomplishment and confirmation)				
Selected an appropriate instructional aid(s).				

CRITERIA	COMMENTS	Incomplete	Completed With Difficulty	Completed Without Difficulty
END OF LESSON CONFIRMATION				
Used questions/activity to confirm knowledge or skills.				
CONCLUSION				
Summarized the lesson.				
Re-motivated the cadets.				
Described the next lesson.				
EFFECTIVE-SPEAKING TECHNIQUES				
Applied the elements of voice control. (pitch, tone, volume, speed, pause and articulation)				
Used appropriate body language.				
Maintaining appropriate dress and deportment.				
QUESTIONING TECHNIQUES				
Choose appropriate types of questions.				
Applied the questioning sequence. (pose, pause, pounce, ponder and praise)				
FEEDBACK				

 Assessor's Signature

 Date

 Cadet's Signature

LIST OF TOPICS

1. Your personal involvement within the cadet squadron.
2. One fun event in which you took part at a Cadet Summer Training Centre.
3. One subject or topic area you would like to see added to/expanded on in the current training program.
4. One goal you have set or attained while in cadets.
5. Where you see yourself within the squadron in the future.
6. One fun event in which you took part with the squadron.
7. Your first night as a cadet.
8. Your first trip with the squadron.
9. Your first visit to the gliding centre.
10. Why you joined cadets.

THIS PAGE INTENTIONALLY LEFT BLANK

VERBAL PRESENTATION – FEEDBACK FORM

Name: _____

Date: _____

Length: 1 min

Start: _____

End: _____

Total: _____

Criteria	Comments	Yes	No
Introduction			
Body			
Conclusion			
Voice			
Body Language			
Dress & Deportment			
Presentation Aid(s)			
Comments:			
STRENGTHS		AREAS FOR IMPROVEMENT	

Instructor's Signature

Cadet's Signature

THIS PAGE INTENTIONALLY LEFT BLANK

THE LESSON PLAN

The lesson plan is a way for the instructor to organize the lesson and summarize information included in the lesson specification, the IG and their personal ideas. Lesson plans provide a set of detailed directions for delivering one or more periods of instruction.

Part	Purpose
1. Introduction	Builds the cadets' interest and motivation.
2. Body	Presents and explains each TP.
3. End of Lesson Confirmation	Confirms cadets' comprehension of the lesson.
4. Conclusion	Summarizes key points and identifies future lessons.

INTRODUCTION

The introduction is the instructor's first verbal interaction with the cadets. It should capture the cadets' interest. The following should be included in the introduction of a lesson plan:

- **What.** A description of what the cadets will be expected to accomplish at the end of the lesson.
- **Why.** A description of how and where the lesson fits into the Cadet Program.
- **Where.** A description of why it is important for the cadets to achieve the objectives.



Read the "Objective" and "Importance" paragraphs in the IG for help in writing the introduction of the lesson plan.

BODY

The body of the lesson plan is where the content is presented, explained and supported. Each TP directs the instructor and the cadets.

Each TP in the lesson includes:

- **Introduction.** Briefly introduce the content to be taught during the TP.
- **Teaching Method.** Identifies which teaching method has been chosen for the given TP.
- **Lesson Content.** Presents the lesson content in a clear and logical order, from easy to difficult or known to unknown.
- **Confirmation.** Confirmation of the TP may be oral questions, games, role-play or an in-class or practical activity. Instructional guides offer suggestions on how to confirm TPs. Instructors may choose to use those confirmation suggestions or develop their own.

END OF LESSON CONFIRMATION

The lesson plan should outline procedures to be used to confirm the learning of the TP. End of lesson confirmations are carried out to ensure that the cadets have understood the whole lesson and that any weaknesses in performance are identified so they may be corrected.

Confirmation activities are based on the lesson objectives. The end of lesson confirmation may be oral questions, games, role-play or an in-class or practical activity. IGs offer suggestions for how to conduct end of lesson confirmations. Instructors may choose to use those confirmation suggestions or develop their own.

CONCLUSION

The conclusion of a lesson allows the instructor to give a summary of key points and link them to the coming lessons and their practical use.

- **A Summary of Important Points and Any Weak Areas.** The summary reviews the main TPs. The depth of the summary will be determined by the lesson objectives and the results of the cadets' end of lesson confirmation/test. If the cadets achieved the objectives successfully, the summary may be brief. If they experienced some difficulties, the instructor should summarize them here and indicate how the issue will be addressed.
- **Re-Motivation Statement.** The re-motivation statement restates the importance of the lesson (the "why") and re-motivates the cadets. The instructor should also take this time to give an overview of the next lesson and any precautions the cadets should be aware of when using the knowledge they have gained in a practical setting.



Read the "Closing Statement" paragraph in the IG for help in writing the conclusion of the lesson plan.

PLAN A DRILL LESSON CHECKLIST

PREPARATION	NOTES
<p>Have you:</p> <ul style="list-style-type: none"> <input type="checkbox"/> Selected an appropriate squad formation? <input type="checkbox"/> Written a lesson plan? 	
INTRODUCTION	
<p>Does your introduction:</p> <ul style="list-style-type: none"> <input type="checkbox"/> Review previous lesson material? <input type="checkbox"/> State what the cadets will learn? <input type="checkbox"/> Describe why the movement is important to learn? <input type="checkbox"/> Describe where and when the movement can be used? <input type="checkbox"/> Describe how the cadets will be assessed? 	
BODY	
<p>Does the body of your lesson:</p> <ul style="list-style-type: none"> <input type="checkbox"/> Demonstrate the complete movement with the instructor calling the time? <input type="checkbox"/> Explain the movement? <input type="checkbox"/> Demonstrate and explain the first part of the movement (Squad 1)? <input type="checkbox"/> Permit practice of the first part of the movement (collectively, individually, collectively)? <input type="checkbox"/> Teach the second and each subsequent movement following the sequence described above? <input type="checkbox"/> Permit practice of the complete movement with: <ul style="list-style-type: none"> <input type="checkbox"/> the instructor calling the time; <input type="checkbox"/> the cadets calling the time; and <input type="checkbox"/> the cadets judging the time? <input type="checkbox"/> Confirm each TP? <input type="checkbox"/> Include two complete demonstrations? 	
END OF LESSON CONFIRMATION	
<ul style="list-style-type: none"> <input type="checkbox"/> Did you conduct an end of lesson confirmation? 	

CONCLUSION	
Does your conclusion:	
<input type="checkbox"/> Restate the movement taught and where or when it will be used?	
<input type="checkbox"/> Re-motivate the cadets by:	
<input type="checkbox"/> comment on the cadets' progress; and	
<input type="checkbox"/> re-state why the drill movement just learned is important?	
<input type="checkbox"/> Describe the next lesson?	

LIST OF APPROVED 15-MINUTE DRILL TOPICS

Teach the movement of attention from stand at ease, and stand at ease from attention (M108.01 [Adopt the Positions of Attention, Stand at Ease and Stand Easy, A-CR-CCP-801/PG-001, Chapter 4, Section 8 and A-CR-CCP-801/PF-001, Chapter 8, Section 1]).

Teach the movement of stand easy from stand at ease, and stand at ease from stand easy (M108.01 [Adopt the Positions of Attention, Stand at Ease and Stand Easy, A-CR-CCP-801/PG-001, Chapter 4, Section 8 and A-CR-CCP-801/PF-001, Chapter 8, Section 1]).

Teach a salute to the front (M108.02 [Execute a Salute at the Halt Without Arms, A-CR-CCP-801/PG-001, Chapter 4, Section 8 and A-CR-CCP-801/PF-001, Chapter 8, Section 2]).

Teach a salute to the right (left) (M108.02 [Execute a Salute at the Halt Without Arms, A-CR-CCP-801/PG-001, Chapter 4, Section 8 and A-CR-CCP-801/PF-001, Chapter 8, Section 2]).

Teach the right turn at the halt (M108.03 [Execute Turns at the Halt, A-CR-CCP-801/PG-001, Chapter 4, Section 8 and A-CR-CCP-801/PF-001, Chapter 8, Section 3]).

Teach the left turn at the halt (M108.03 [Execute Turns at the Halt, A-CR-CCP-801/PG-001, Chapter 4, Section 8 and A-CR-CCP-801/PF-001, Chapter 8, Section 3]).

Teach the about turn at the halt (M108.03 [Execute Turns at the Halt, A-CR-CCP-801/PG-001, Chapter 4, Section 8 and A-CR-CCP-801/PF-001, Chapter 8, Section 3]).

THIS PAGE INTENTIONALLY LEFT BLANK

MODIFIED LESSON INSTRUCTIONS AND INSTRUCTIONAL GUIDES – MOVEMENT OF ATTENTION FROM STAND AT EASE, AND STAND AT EASE FROM ATTENTION

A-CR-CCP-801/PG-001

EO M108.01 – ADOPT THE POSITIONS OF ATTENTION, STAND AT EASE, AND STAND EASY

1. **Performance.** Adopt the Positions of Attention, Stand at Ease, and Stand Easy.
2. **Conditions**
 - a. Given:
 - (1) words of command;
 - (2) supervision; and
 - (3) assistance as required.
 - b. Denied: N/A.
 - c. Environmental: A drill hall or, in favourable weather, an outdoor parade square.
3. **Standard.** In accordance with A-PD-201-000/PT-000, the cadet shall perform the following individual drill movements:
 - a. attention from stand at ease; and
 - b. stand at ease from attention.

4. **Teaching Points**

TP	Description	Method	Time	Ref
TP1	Explain and demonstrate the movement of attention from stand at ease and allow cadets to practice.	Demonstration and Performance	5 min	A0-002 (pp. 2-2 to 2-8)
TP2	Explain and demonstrate the movement of stand at ease from attention and allow cadets to practice.	Demonstration and Performance	5 min	A0-002 (pp. 2-2 to 2-8)

5. **Time**
 - a. Introduction/Conclusion: 5 min
 - b. Demonstration and Performance: 10 min
 - c. Total: 15 min
6. **Substantiation.** The demonstration-performance method was chosen to allow cadets to participate in supervised exploration of practical instructional material. This method provides the instructor the opportunity to introduce the subject matter, demonstrate and explain procedures, and supervise the cadets while they imitate the skill. This method appeals to all learning styles.
7. **References.** A0-002 A-PD-201-000/PT-000 DHH 3-2. (2001). *The Canadian Forces Manual of Drill and Ceremonial*. Ottawa, ON: The Department of National Defence.
8. **Training Aids.** Assistant instructors as required.
9. **Learning Aids.** N/A.

A-CR-CCP-801/PG-001

10. **Test Details.** There is no formal assessment of this EO. Instructors will confirm the cadets' ability to perform the movements during the end of lesson check, and ongoing feedback will be provided during future drill practices, weekly parade nights, and ceremonial parades.
11. **Remarks.** N/A.

A-CR-CCP-801/PF-001



**COMMON TRAINING
PROFICIENCY LEVEL ONE
INSTRUCTIONAL GUIDE**



SECTION 1

EO M108.01 – ADOPT THE POSITIONS OF ATTENTION, STAND AT EASE AND STAND EASY

Total Time: 15 min

PREPARATION

PRE-LESSON INSTRUCTIONS

A complete list of resources needed for the instruction of this EO is located at Chapter 4 of the QSP. Specific uses for said stores are identified throughout the Instructional Guide, within the teaching point for which they are required.

Prior to instructing this lesson the instructor shall:

- review the lesson content, and become familiar with the material; and
- select the most effective squad formation for the lesson being taught. A squad may be in a single rank, hollow square or semi-circle for elementary drill instruction. (Note: All cadets **must** be able to fully observe all demonstrations and explanations.)

PRE-LESSON ASSIGNMENT

N/A.

APPROACH

This lesson will be presented using the demonstration and performance method. The demonstration and performance method was chosen to allow cadets to participate in supervised exploration of practical instructional material. This method provides the instructor the opportunity to introduce the subject matter, demonstrate and explain procedures, and supervise the cadets while they imitate the skill. This method appeals to all learning styles.



The instructor shall develop and use a vocabulary of short, concise words to impress on the squad that the movements must be performed smartly. For example, the words “crack”, “drive”, “seize” and “grasp” suggest the degree of smartness required. Profanity or personal sarcasm shall never be used.

INTRODUCTION

REVIEW

N/A.

A-CR-CCP-801/PF-001

OBJECTIVES

By the end of this lesson the cadet shall be expected to adopt the positions of attention and stand at ease.

IMPORTANCE

As members of the Canadian Cadet Movement (CCM) cadets will be required to perform drill movements at a competent level, developing sharpness, esprit de corps, physical coordination, and alertness. These movements will be executed with ease and without hesitation. Ensuring that the cadets efficiently move together as one will promote discipline, alertness, precision, pride, steadiness, and cohesion. This develops the basis of teamwork that the CCM depends on.

Teaching Point 1

Adopting the Position of Attention From Stand at Ease

Time: 5 min

Method: Demonstration and Performance



Instructors are reminded that they are to present the example with regards to drill, from the moment they step onto the parade square. Proper drill movements, combined with a professional demeanour, are of paramount importance, and must be exemplified throughout the period of instruction.

DEMONSTRATE THE COMPLETE MOVEMENT WITH TIMING

The instructor shall provide a complete demonstration of the drill movement, with timing. A practiced assistant instructor may carry out this demonstration.

The demonstration shall be provided from various vantage points, as required.

DEMONSTRATE FIRST PART OF MOVEMENT (FIRST NUMBER)



For ease of instruction, drill commands have been broken down into individual movements, or numbers. The instructor(s) shall demonstrate and explain each number.

In order to adopt the position of attention from stand at ease, the cadet shall:

On the command ATTENTION BY NUMBERS, SQUAD – ONE, bend the left knee and shift the balance to the right foot.

PRACTICE THE SQUAD ON THE FIRST MOVEMENT

Practice the squad on the first movement collectively, individually and collectively.

DEMONSTRATE AND EXPLAIN THE SECOND PART OF THE MOVEMENT

On the command SQUAD – TWO:

1. straighten the left leg in double time, place the foot smartly on the ground, toe touching first, followed by the heel, and with heels aligned; and
2. simultaneously, with a quick motion, bring the arms and hands to the position of attention.

A-CR-CCP-801/PF-001

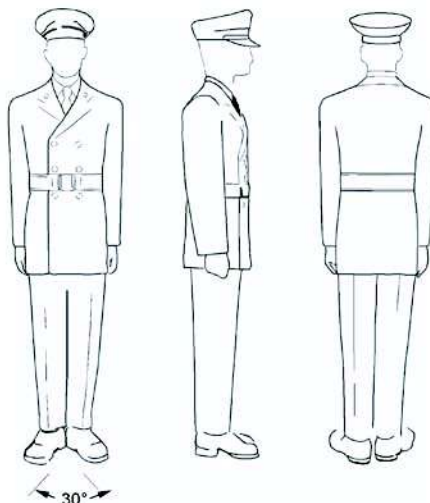

A-PD-201-000/PT-000, *The Canadian Forces Manual of Drill and Ceremonial, 2001*

Figure 8-1-1 The Position of Attention



A-PD-201-000/PT-000, *The Canadian Forces Manual of Drill and Ceremonial, 2001*

Figure 8-1-2 Fists at Position of Attention



Constant checking and correcting of all faults is essential. Faults shall be corrected immediately after they occur.

GIVE TWO COMPLETE AND FINAL DEMONSTRATIONS

On the command ATTEN – TION, combine the two movements. The timing is called as “one.”

The instructor(s) shall provide a full demonstration and allow time for practice.

CONFIRMATION OF TEACHING POINT 1

Cadets will adopt the position of attention as a squad.

A-CR-CCP-801/PF-001

Teaching Point 2

Adopting the Position of Stand at Ease From Attention

Time: 5 min

Method: Demonstration and Performance

DEMONSTRATE THE COMPLETE MOVEMENT WITH TIMING

The position of standing at ease is an intermediate position between attention and standing easy. It allows no relaxation, but can be maintained without strain for a longer time than the position of attention.

DEMONSTRATE FIRST PART OF MOVEMENT (FIRST NUMBER)



For ease of instruction, drill commands have been broken down into individual movements, or numbers. The instructor(s) shall demonstrate and explain each number.

On the command STAND AT EASE BY NUMBERS, SQUAD – ONE, the cadet shall bend the left knee.

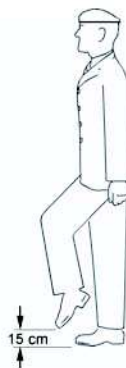

A-PD-201-000/PT-000, The Canadian Forces Manual of Drill and Ceremonial, 2001

Figure 8-1-3 Squad One – Stand at Ease

PRACTICE THE SQUAD ON THE FIRST MOVEMENT

Practice the squad on the first movement collectively, individually and collectively.

DEMONSTRATE AND EXPLAIN THE SECOND PART OF THE MOVEMENT (SECOND NUMBER)

On the command SQUAD – TWO, the cadet shall:

1. carry the left foot to the left, straightening it in double time, and place it smartly flat on the ground with the inside of the heels 25 cm apart;
2. simultaneously, with a quick motion, bring the arms behind the back, stretched to their full extent, and place the back of the right hand in the palm of the left, with thumbs crossed right over left, the fingers together and extended; and
3. balance the body with the weight evenly distributed on both feet.

A-CR-CCP-801/PF-001

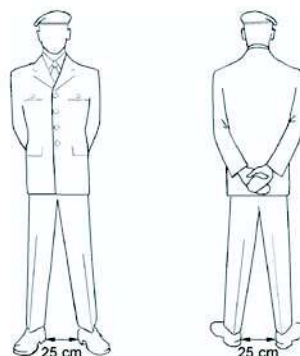

A-PD-201-000/PT-000, *The Canadian Forces Manual of Drill and Ceremonial, 2001*

Figure 8-1-4 The Position of Stand at Ease

PRACTICE THE SQUAD ON THE SECOND MOVEMENT

Practice the squad on the second movement collectively, individually and collectively.

GIVE TWO COMPLETE AND FINAL DEMONSTRATIONS

On the command STAND AT – EASE, combine the two movements. The timing is “one.”

The instructor(s) shall provide a full demonstration and allow time for practice.



Constant checking and correcting of all faults is essential. Faults shall be corrected immediately after they occur.

CONFIRMATION OF TEACHING POINT 2

Cadets will adopt the position of stand at ease as a squad.

END OF LESSON CONFIRMATION

The confirmation for this lesson should consist of the cadets, as a squad, practicing the positions of attention, stand at ease and stand easy, and should emphasize movements that cadets showed difficulty with during the class.

Practice the complete movement, with the:

- **instructor** calling the time;
- **squad** calling the time; and
- **squad judging** the time.

A-CR-CCP-801/PF-001

CONCLUSION

HOMEWORK/READING/PRACTICE

Drill movements are skills that must be practiced individually, in order to make the cadet more proficient as a member of a unit. Cadets are encouraged to practice the movements, as opportunities are made available. Ongoing feedback will be provided, and should be heeded during any drill practice.

METHOD OF EVALUATION

In accordance with A-PD-201-000/PT-000, *The Canadian Forces Manual of Drill and Ceremonial*, the cadet shall participate in an Annual Ceremonial Review (ACR) parade. This movement will be used in preparation for, and in the execution of, the ACR parade.

CLOSING STATEMENT

The hallmarks of cadet drill are efficiency, precision, and dignity. These qualities are developed through self-discipline and practice. They lead to unit pride and cohesion. Good drill that is well rehearsed, closely supervised and precise, is an exercise in obedience and alertness. It sets the standard for the execution of any duty, both for the individual and the unit, and builds a sense of confidence between commander and subordinate that is essential to high morale. The personal qualities developed on the parade ground must be maintained in all aspects of life.

INSTRUCTOR NOTES/REMARKS

N/A.

REFERENCES

A0-002 A-PD-201-000/PT-000, DHH 3-2. (2001). *The Canadian Forces Manual of Drill and Ceremonial*. Ottawa, ON: The Department of National Defence.

**MODIFIED LESSON INSTRUCTIONS AND INSTRUCTIONAL GUIDES – MOVEMENT OF
STAND EASY FROM STAND AT EASE, AND STAND AT EASE FROM STAND EASY**

A-CR-CCP-801/PG-001

EO M108.01 – ADOPT THE POSITIONS OF ATTENTION, STAND AT EASE, AND STAND EASY

1. **Performance.** Adopt the Positions of Attention, Stand at Ease, and Stand Easy.
2. **Conditions**
 - a. Given:
 - (1) words of command;
 - (2) supervision; and
 - (3) assistance as required.
 - b. Denied: N/A.
 - c. Environmental: A drill hall or, in favourable weather, an outdoor parade square.
3. **Standard.** In accordance with A-PD-201-000/PT-000, the cadet shall perform the following individual drill movements:
 - a. stand easy from stand at ease; and
 - b. stand at ease from stand easy

4. **Teaching Points**

TP	Description	Method	Time	Ref
TP1	Explain and demonstrate the movement of stand easy from stand at ease and allow cadets to practice.	Demonstration and Performance	5 min	A0-002 (pp. 2-2 to 2-8)
TP2	Explain and demonstrate the movement of stand at ease from stand easy and allow cadets to practice.	Demonstration and Performance	5 min	A0-002 (pp. 2-2 to 2-8)

5. **Time**
 - a. Introduction/Conclusion: 5 min
 - b. Demonstration and Performance: 10 min
 - c. Total: 15 min
6. **Substantiation.** The demonstration-performance method was chosen to allow cadets to participate in supervised exploration of practical instructional material. This method provides the instructor the opportunity to introduce the subject matter, demonstrate and explain procedures, and supervise the cadets while they imitate the skill. This method appeals to all learning styles.
7. **References.** A0-002 A-PD-201-000/PT-000 DHH 3-2. (2001). *The Canadian Forces Manual of Drill and Ceremonial*. Ottawa, ON: The Department of National Defence.
8. **Training Aids.** Assistant instructors as required.
9. **Learning Aids.** N/A.

A-CR-CCP-801/PG-001

10. **Test Details.** There is no formal assessment of this EO. Instructors will confirm the cadets' ability to perform the movements during the end of lesson check, and ongoing feedback will be provided during future drill practices, weekly parade nights, and ceremonial parades.
11. **Remarks.** N/A.

A-CR-CCP-801/PF-001



**COMMON TRAINING
PROFICIENCY LEVEL ONE
INSTRUCTIONAL GUIDE**



SECTION 1

EO M108.01 – ADOPT THE POSITIONS OF ATTENTION, STAND AT EASE AND STAND EASY

Total Time: 15 min

PREPARATION

PRE-LESSON INSTRUCTIONS

A complete list of resources needed for the instruction of this EO is located at Chapter 4 of the QSP. Specific uses for said stores are identified throughout the Instructional Guide, within the teaching point for which they are required.

Prior to instructing this lesson the instructor shall:

- review the lesson content, and become familiar with the material; and
- select the most effective squad formation for the lesson being taught. A squad may be in a single rank, hollow square or semi-circle for elementary drill instruction. (Note: All cadets **must** be able to fully observe all demonstrations and explanations.)

PRE-LESSON ASSIGNMENT

N/A.

APPROACH

This lesson will be presented using the demonstration and performance method. The demonstration and performance method was chosen to allow cadets to participate in supervised exploration of practical instructional material. This method provides the instructor the opportunity to introduce the subject matter, demonstrate and explain procedures, and supervise the cadets while they imitate the skill. This method appeals to all learning styles.



The instructor shall develop and use a vocabulary of short, concise words to impress on the squad that the movements must be performed smartly. For example, the words “crack”, “drive”, “seize” and “grasp” suggest the degree of smartness required. Profanity or personal sarcasm shall never be used.

INTRODUCTION

REVIEW

N/A.

A-CR-CCP-801/PF-001

IMPORTANCE

As members of the Canadian Cadet Movement (CCM) cadets will be required to perform drill movements at a competent level, developing sharpness, esprit de corps, physical coordination, and alertness. These movements will be executed with ease and without hesitation. Ensuring that the cadets efficiently move together as one will promote discipline, alertness, precision, pride, steadiness, and cohesion. This develops the basis of teamwork that the CCM depends on.

Teaching Point 1

Adopting the Position of Stand Easy

Time: 5 min

Method: Demonstration and Performance

DEMONSTRATE THE COMPLETE MOVEMENT WITH TIMING



Instructors are reminded that they are to present the example with regards to drill, from the moment they step onto the parade square. Proper drill movements, combined with a professional demeanour, are of paramount importance, and must be exemplified throughout the period of instruction.

DEMONSTRATE THE COMPLETE MOVEMENT WITH TIMING

The instructor shall provide a complete demonstration of the drill movement, with timing. A practiced assistant instructor may carry out this demonstration.

The demonstration shall be provided from various vantage points, as required.

The position of stand easy is ordered when it is desirable to permit cadets to relax. This command is only given when the squad is in the position of stand at ease.

On the command STAND – EASY, the cadet shall:

1. close the hands and bring the arms to the position of attention; and
2. relax.

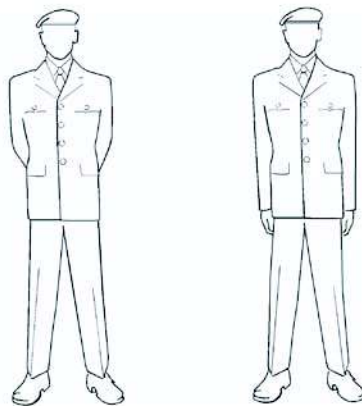

A-PD-201-000/PT-000, The Canadian Forces Manual of Drill and Ceremonial, 2001

Figure 8-1-1 Stand Easy From Stand at Ease

A-CR-CCP-801/PF-001



When standing easy, the cadet may, with permission, move all but the feet and adjust clothing and equipment, but shall not talk.

PRACTICE THE COMPLETE MOVEMENT WITH TIMING

Practice the squad on the first movement collectively, individually and collectively.

GIVE TWO COMPLETE AND FINAL DEMONSTRATIONS

Combine the preceding movements with timing. The instructor(s) shall provide a full demonstration and allow time for practice.



Constant checking and correcting of all faults is essential. Faults shall be corrected immediately after they occur.

CONFIRMATION OF TEACHING POINT 1

Cadets will adopt the position of stand easy as a squad.

Teaching Point 2

Adopting the Position of Stand at Ease From Standing Easy

Time: 5 min

Method: Demonstration and Performance

DEMONSTRATE THE COMPLETE MOVEMENT WITH TIMING

The instructor shall provide a complete demonstration of the drill movement, with timing. A practiced assistant instructor may carry out this demonstration.

The demonstration shall be provided from various vantage points, as required.

In order to adopt the position of stand at ease from easy the cadet shall, on the cautionary command SQUAD (or formation title), assume the position of stand at ease.

A-CR-CCP-801/PF-001

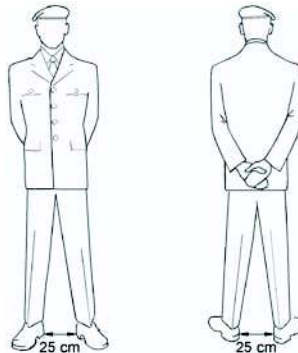

A-PD-201-000/PT-000, The Canadian Forces Manual of Drill and Ceremonial, 2001

Figure 8-1-2 The Position of Stand at Ease



This teaching point is best taught as a group practice to ensure adherence to timings and togetherness of the squad.



Constant checking and correcting of all faults is essential. Faults shall be corrected immediately after they occur.

CONFIRMATION OF TEACHING POINT 2

Cadets will adopt the position of stand at ease as a squad.

END OF LESSON CONFIRMATION

The confirmation for this lesson should consist of the cadets, as a squad, practicing the positions of attention, stand at ease and stand easy, and should emphasize movements that cadets showed difficulty with during the class.

Practice the complete movement, with the:

- **instructor** calling the time;
- **squad** calling the time; and
- squad **judging** the time.

A-CR-CCP-801/PF-001

CONCLUSION

HOMEWORK/READING/PRACTICE

Drill movements are skills that must be practiced individually, in order to make the cadet more proficient as a member of a unit. Cadets are encouraged to practice the movements, as opportunities are made available. Ongoing feedback will be provided, and should be heeded during any drill practice.

METHOD OF EVALUATION

In accordance with A-PD-201-000/PT-000, *The Canadian Forces Manual of Drill and Ceremonial*, the cadet shall participate in an Annual Ceremonial Review (ACR) parade. This movement will be used in preparation for, and in the execution of, the ACR parade.

CLOSING STATEMENT

The hallmarks of cadet drill are efficiency, precision, and dignity. These qualities are developed through self-discipline and practice. They lead to unit pride and cohesion. Good drill that is well rehearsed, closely supervised and precise, is an exercise in obedience and alertness. It sets the standard for the execution of any duty, both for the individual and the unit, and builds a sense of confidence between commander and subordinate that is essential to high morale. The personal qualities developed on the parade ground must be maintained in all aspects of life.

INSTRUCTOR NOTES/REMARKS

N/A.

REFERENCES

A0-002 A-PD-201-000/PT-000, DHH 3-2. (2001). *The Canadian Forces Manual of Drill and Ceremonial*. Ottawa, ON: The Department of National Defence.

THIS PAGE INTENTIONALLY LEFT BLANK

MODIFIED LESSON INSTRUCTIONS AND INSTRUCTIONAL GUIDES – SALUTE TO THE FRONT

A-CR-CCP-801/PG-001

EO M108.02 – EXECUTE A SALUTE AT THE HALT WITHOUT ARMS

1. **Performance.** Execute a Salute at the Halt Without Arms.
2. **Conditions**
 - a. Given:
 - (1) words of command;
 - (2) supervision; and
 - (3) assistance as required.
 - b. Denied: N/A.
 - c. Environmental: A drill hall or, in favourable weather, an outdoor parade square.
3. **Standard.** In accordance with A-PD-201-000/PT-000, the cadet shall execute salutes at the halt without arms, to the front.

4. **Teaching Points**

TP	Description	Method	Time	Ref
TP1	Explain and demonstrate saluting to the front at the halt and allow cadets to practice.	Demonstration and Performance	10 min	A0-002 (pp. 2-10 to 2-12)

5. **Time**
 - a. Introduction/Conclusion: 5 min
 - b. Demonstration and Performance: 10 min
 - c. Total: 15 min
6. **Substantiation.** The demonstration-performance method was chosen to allow cadets to participate in supervised exploration of practical instructional material. This method provides the instructor the opportunity to introduce the subject matter, demonstrate and explain procedures, and supervise the cadets while they imitate the skill. This method appeals to all learning styles.
7. **References.** A0-002 A-PD-201-000/PT-000 DHH 3-2. (2001). *The Canadian Forces Manual of Drill and Ceremonial*. Ottawa, ON: The Department of National Defence.
8. **Training Aids.** Assistant instructors as required.
9. **Learning Aids.** N/A.
10. **Test Details.** There is no formal assessment of this EO. Instructors will confirm the cadets' ability to perform the movements during the end of lesson check, and ongoing feedback will be provided during future drill practices, weekly parade nights, and ceremonial parades.
11. **Remarks.** N/A.



**COMMON TRAINING
PROFICIENCY LEVEL TWO
INSTRUCTIONAL GUIDE**



SECTION 2

EO M108.02 – EXECUTE A SALUTE AT THE HALT WITHOUT ARMS

Total Time: 15 min

PREPARATION

PRE-LESSON INSTRUCTIONS

A complete list of resources needed for the instruction of this EO is located at Chapter 4 of the QSP. Specific uses for said stores are identified throughout the Instructional Guide, within the teaching point for which they are required.

Prior to instructing this lesson the instructor shall:

- review the lesson content, and become familiar with the material; and
- select the most effective squad formation for the lesson being taught. A squad may be in a single rank, hollow square or semi-circle for elementary drill instruction. (Note: All cadets **must** be able to fully observe all demonstrations and explanations.)

PRE-LESSON ASSIGNMENT

N/A.

APPROACH

This lesson will be presented using the demonstration and performance method. The demonstration and performance method was chosen to allow cadets to participate in supervised exploration of practical instructional material. This method provides the instructor the opportunity to introduce the subject matter, demonstrate and explain procedures, and supervise the cadets while they imitate the skill. This method appeals to all learning styles.



The instructor shall develop and use a vocabulary of short, concise words to impress on the squad that the movements must be performed smartly. For example, the words “crack”, “drive”, “seize” and “grasp” suggest the degree of smartness required. Profanity or personal sarcasm shall never be used.

INTRODUCTION

REVIEW

N/A.

A-CR-CCP-801/PF-001

OBJECTIVES

By the end of this lesson the cadet shall be expected to execute a salute at the halt without arms.

IMPORTANCE

As members of the Canadian Cadet Organization (CCO) cadets will be required to perform drill movements at a competent level, developing sharpness, esprit de corps, physical coordination, and alertness. These movements will be executed with ease and without hesitation. Ensuring that the cadets efficiently move together as one will promote discipline, alertness, precision, pride, steadiness, and cohesion. This develops the basis of teamwork that the CCO depends on.

Teaching Point 1

Execute a Salute to the Front

Time: 10 min

Method: Demonstration and Performance

DEMONSTRATE THE COMPLETE MOVEMENT WITH TIMING



Instructors are reminded that they are to present the example with regards to drill, from the moment they step onto the parade square. Proper drill movements, combined with a professional demeanour, are of paramount importance, and must be exemplified throughout the period of instruction.

The instructor shall provide a complete demonstration of the drill movement, with timing. A practiced assistant instructor may carry out this demonstration.

The demonstration shall be provided from various vantage points, as required.

The salute is given with the right hand. When physical incapacity or carrying of articles makes a salute with the right hand impracticable, compliments will be paid by turning the head and eyes to the left or right or standing to attention, as appropriate (see also A-PD-201-000/PT-000, Chapter 1, Section 2).

DEMONSTRATE FIRST PART OF MOVEMENT (FIRST NUMBER)



For ease of instruction, drill commands have been broken down into individual movements, or numbers. The instructor(s) shall demonstrate and explain each number.

On the command TO THE FRONT SALUTE BY NUMBERS, SQUAD – ONE, the cadet shall:

1. bend the right elbow and open the palm of the right hand as it passes the shoulder; and
2. force the right hand by its shortest route to the front of the headdress so that the:
 - a. palm of the hand is facing down;
 - b. thumb and fingers are fully extended and close together;
 - c. tip of the second finger is in line with the outside of the right eyebrow and touching the outside edge of the headdress or arm of glasses, if worn;
 - d. hand, wrist and forearm are in a straight line and at a 45-degree angle to the upper arm;

- e. elbow is in line with the shoulders; and
- f. upper arm is parallel to the ground.

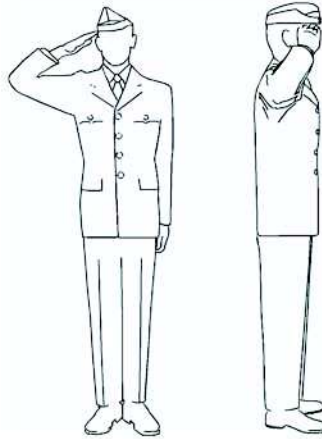

A-PD-201-000/PT-000, The Canadian Forces Manual of Drill and Ceremonial, 2001

Figure 8-2-1 Saluting to the Front Without Arms

PRACTICE THE SQUAD ON THE FIRST MOVEMENT

Practice the squad on the first movement collectively, individually and collectively.



Constant checking and correcting of all faults is essential. Faults shall be corrected immediately after they occur.

DEMONSTRATE AND EXPLAIN THE SECOND PART OF THE MOVEMENT

On the command SQUAD – TWO, the hand is:

1. brought sharply to the position of attention by the shortest route, without slapping the thigh; and
2. closed after the forearm is lowered below shoulder level.

PRACTICE THE SQUAD ON THE SECOND MOVEMENT

Practice the squad on the second movement collectively, individually and collectively.

GIVE TWO COMPLETE AND FINAL DEMONSTRATIONS

On the command TO THE FRONT – SALUTE, the two movements are combined. The standard pause shall be observed between movements.

The instructor(s) shall provide a full demonstration and allow time for practice.

Note: When wearing headdress, other than a cap with a peak, the second finger is 2 cm above and in line with the outer tip of the right eyebrow.

A-CR-CCP-801/PF-001



Standard Pause: The standard pause between each movement is two beats in quick time. For example, on the command MOVE TO THE RIGHT IN FILE, RIGHT – TURN, the squad:

1. executes the first movement of the turn on the executive order and simultaneously calls out "ONE";
2. after completing the first movement, calls "TWO", "THREE" while observing the standard pause; and
3. when executing the final movement, calls out "ONE".

CONFIRMATION OF TEACHING POINT 1

Cadets will execute salutes to the front as a squad.

END OF LESSON CONFIRMATION

The cadets' participation in TP1 will serve as the confirmation of this lesson.

CONCLUSION

HOMEWORK/READING/PRACTICE

N/A.

METHOD OF EVALUATION

In accordance with A-PD-201-000/PT-000, *The Canadian Forces Manual of Drill and Ceremonial*, the cadet shall participate in an Annual Ceremonial Review (ACR) parade. This movement will be used in preparation for, and execution of, the ACR parade.

CLOSING STATEMENT

The hallmarks of cadet drill are efficiency, precision, and dignity. These qualities are developed through self-discipline and practice. They lead to unit pride and cohesion. Good drill, that is well rehearsed, closely supervised and precise, is an exercise in obedience and alertness. It sets the standard for the execution of any duty, both for the individual and the unit, and builds a sense of confidence between commander and subordinate that is essential to high morale. The personal qualities developed on the parade ground must be maintained in all aspects of life.

INSTRUCTOR NOTES/REMARKS

N/A.

REFERENCES

A0-002 A-PD-201-000/PT-000, DHH 3-2. (2001). *The Canadian Forces Manual of Drill and Ceremonial*. Ottawa, ON: The Department of National Defence.

THIS PAGE INTENTIONALLY LEFT BLANK

MODIFIED LESSON INSTRUCTIONS AND INSTRUCTIONAL GUIDES – SALUTE TO THE RIGHT (LEFT)

A-CR-CCP-801/PG-001

EO M108.02 – EXECUTE A SALUTE AT THE HALT WITHOUT ARMS

1. **Performance.** Execute a Salute at the Halt Without Arms.
2. **Conditions**
 - a. Given:
 - (1) words of command;
 - (2) supervision; and
 - (3) assistance as required.
 - b. Denied: N/A.
 - c. Environmental: A drill hall or, in favourable weather, an outdoor parade square.
3. **Standard.** In accordance with A-PD-201-000/PT-000, the cadet shall execute salutes at the halt without arms, to the left, and right.

4. **Teaching Points**

TP	Description	Method	Time	Ref
TP1	Explain and demonstrate saluting to the left and right at the halt and allow cadets to practice.	Demonstration and Performance	10 min	A0-002 (pp. 2-10 to 2-12)

5. **Time**
 - a. Introduction/Conclusion: 5 min
 - b. Demonstration and Performance: 10 min
 - c. Total: 15 min
6. **Substantiation.** The demonstration-performance method was chosen to allow cadets to participate in supervised exploration of practical instructional material. This method provides the instructor the opportunity to introduce the subject matter, demonstrate and explain procedures, and supervise the cadets while they imitate the skill. This method appeals to all learning styles.
7. **References.** A0-002 A-PD-201-000/PT-000 DHH 3-2. (2001). *The Canadian Forces Manual of Drill and Ceremonial*. Ottawa, ON: The Department of National Defence.
8. **Training Aids.** Assistant instructors as required.
9. **Learning Aids.** N/A.
10. **Test Details.** There is no formal assessment of this EO. Instructors will confirm the cadets' ability to perform the movements during the end of lesson check, and ongoing feedback will be provided during future drill practices, weekly parade nights, and ceremonial parades.
11. **Remarks.** N/A.



**COMMON TRAINING
PROFICIENCY LEVEL TWO
INSTRUCTIONAL GUIDE**



SECTION 2

EO M108.02 – EXECUTE A SALUTE AT THE HALT WITHOUT ARMS

Total Time: 15 min

PREPARATION

PRE-LESSON INSTRUCTIONS

A complete list of resources needed for the instruction of this EO is located at Chapter 4 of the QSP. Specific uses for said stores are identified throughout the Instructional Guide, within the teaching point for which they are required.

Prior to instructing this lesson the instructor shall:

- review the lesson content, and become familiar with the material; and
- select the most effective squad formation for the lesson being taught. A squad may be in a single rank, hollow square or semi-circle for elementary drill instruction. (Note: All cadets **must** be able to fully observe all demonstrations and explanations.)

PRE-LESSON ASSIGNMENT

N/A.

APPROACH

This lesson will be presented using the demonstration and performance method. The demonstration and performance method was chosen to allow cadets to participate in supervised exploration of practical instructional material. This method provides the instructor the opportunity to introduce the subject matter, demonstrate and explain procedures, and supervise the cadets while they imitate the skill. This method appeals to all learning styles.



The instructor shall develop and use a vocabulary of short, concise words to impress on the squad that the movements must be performed smartly. For example, the words "crack", "drive", "seize" and "grasp" suggest the degree of smartness required. Profanity or personal sarcasm shall never be used.

INTRODUCTION

REVIEW

N/A.

A-CR-CCP-801/PF-001

OBJECTIVES

By the end of this lesson the cadet shall be expected to execute a salute at the halt without arms.

IMPORTANCE

As members of the Canadian Cadet Organization (CCO) cadets will be required to perform drill movements at a competent level, developing sharpness, esprit de corps, physical coordination, and alertness. These movements will be executed with ease and without hesitation. Ensuring that the cadets efficiently move together as one will promote discipline, alertness, precision, pride, steadiness, and cohesion. This develops the basis of teamwork that the CCO depends on.

Teaching Point 1

Execute a Salute to the Right (Left)

Time: 10 min

Method: Demonstration and Performance

DEMONSTRATE THE COMPLETE MOVEMENT WITH TIMING



Instructors are reminded that they are to present the example with regards to drill, from the moment they step onto the parade square. Proper drill movements, combined with a professional demeanour, are of paramount importance, and must be exemplified throughout the period of instruction.

The instructor shall provide a complete demonstration of the drill movement, with timing. A practiced assistant instructor may carry out this demonstration.

The demonstration shall be provided from various vantage points, as required.

The salute is given with the right hand. When physical incapacity or carrying of articles makes a salute with the right hand impracticable, compliments will be paid by turning the head and eyes to the left or right or standing to attention, as appropriate (see also A-PD-201-000/PT-000, Chapter 1, Section 2).

DEMONSTRATE FIRST PART OF MOVEMENT (FIRST NUMBER)



For ease of instruction, drill commands have been broken down into individual movements, or numbers. The instructor(s) shall demonstrate and explain each number.

On the command TO THE RIGHT (LEFT) SALUTE BY NUMBERS, SQUAD – ONE, saluting shall:

1. bend the right elbow and open the palm of the right hand as it passes the shoulder; and
2. force the right hand by its shortest route to the front of the headdress so that the:
 - a. palm of the hand is facing down;
 - b. thumb and fingers are fully extended and close together;
 - c. tip of the second finger is in line with the outside of the right eyebrow and touching the outside edge of the headdress or arm of glasses, if worn;
 - d. hand, wrist and forearm are in a straight line and at a 45 degree angle to the upper arm; and
 - e. upper arm is parallel to the ground.

3. the head and eyes shall be turned smartly to the right (left) as far as possible without straining, remembering the following:
 - a. when saluting to the left, the right hand, wrist and arm are brought further over to the left to the correct position in line with the outside edge of the right eyebrow; and
 - b. when saluting to the right, the arm is moved to the rear, with the tip of the second finger remaining in line with the outside edge of the right eyebrow.

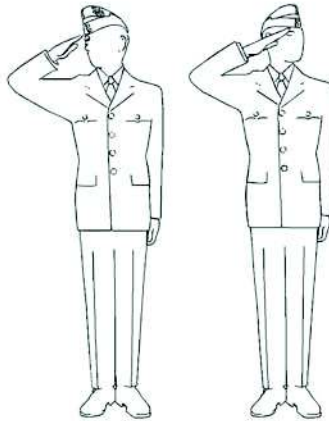

A-PD-201-000/PT-000, The Canadian Forces Manual of Drill and Ceremonial, 2001

Figure 8-2-2 Saluting to the Right and Left

PRACTICE THE SQUAD ON THE FIRST MOVEMENT

Practice the squad on the first movement collectively, individually and collectively.



Constant checking and correcting of all faults is essential. Faults shall be corrected immediately after they occur.

DEMONSTRATE AND EXPLAIN THE SECOND PART OF THE MOVEMENT

On the command SQUAD – TWO, the hand is brought sharply to the position of attention, and simultaneously the head and eyes are turned smartly to the front.

PRACTICE THE SQUAD ON THE SECOND MOVEMENT

Practice the squad on the second movement collectively, individually and collectively.

GIVE TWO COMPLETE AND FINAL DEMONSTRATIONS

On the command TO THE RIGHT (LEFT) – SALUTE, the two movements are combined. The standard pause shall be observed between movements.

The instructor(s) shall provide a full demonstration and allow time for practice.

A-CR-CCP-801/PF-001



Standard Pause: The standard pause between each movement is two beats in quick time. For example, on the command MOVE TO THE RIGHT IN FILE, RIGHT – TURN, the squad:

1. executes the first movement of the turn on the executive order and simultaneously calls out "ONE";
2. after completing the first movement, calls "TWO", "THREE" while observing the standard pause; and
3. when executing the final movement, calls out "ONE".

CONFIRMATION OF TEACHING POINT 1

Cadets will execute salutes to the left and left as a squad.

END OF LESSON CONFIRMATION

The cadets' participation in TP1 will serve as the confirmation of this lesson.

CONCLUSION

HOMEWORK/READING/PRACTICE

N/A.

METHOD OF EVALUATION

In accordance with A-PD-201-000/PT-000, *The Canadian Forces Manual of Drill and Ceremonial*, the cadet shall participate in an Annual Ceremonial Review (ACR) parade. This movement will be used in preparation for, and execution of, the ACR parade.

CLOSING STATEMENT

The hallmarks of cadet drill are efficiency, precision, and dignity. These qualities are developed through self-discipline and practice. They lead to unit pride and cohesion. Good drill, that is well rehearsed, closely supervised and precise, is an exercise in obedience and alertness. It sets the standard for the execution of any duty, both for the individual and the unit, and builds a sense of confidence between commander and subordinate that is essential to high morale. The personal qualities developed on the parade ground must be maintained in all aspects of life.

INSTRUCTOR NOTES/REMARKS

N/A.

REFERENCES

A0-002 A-PD-201-000/PT-000, DHH 3-2. (2001). *The Canadian Forces Manual of Drill and Ceremonial*. Ottawa, ON: The Department of National Defence.

THIS PAGE INTENTIONALLY LEFT BLANK

MODIFIED LESSON INSTRUCTIONS AND INSTRUCTIONAL GUIDES – RIGHT TURN AT THE HALT

A-CR-CCP-801/PG-001

EO M108.03 – EXECUTE TURNS AT THE HALT

1. **Performance.** Execute Turns at the Halt.
2. **Conditions**
 - a. Given:
 - (1) words of command;
 - (2) supervision; and
 - (3) assistance as required.
 - b. Denied: N/A.
 - c. Environmental: A drill hall or, in favourable weather, an outdoor parade square.
3. **Standard.** In accordance with A-PD-201-000/PT-000, the cadet shall perform the movement of right turn at the halt.
4. **Teaching Points**

TP	Description	Method	Time	Ref
TP1	Explain and demonstrate the movement of right turn at the halt and allow cadets to practice.	Demonstration and Performance	10 min	A0-002 (pp. 2-12 to 2-13)

5. **Time**
 - a. Introduction/Conclusion: 5 min
 - b. Demonstration and Performance: 10 min
 - c. Total: 15 min
6. **Substantiation.** The demonstration-performance method was chosen to allow cadets to participate in supervised exploration of practical instructional material. This method provides the instructor the opportunity to introduce the subject matter, demonstrate and explain procedures, and supervise the cadets while they imitate the skill. This method appeals to all learning styles.
7. **References.** A0-002 A-PD-201-000/PT-000 DHH 3-2. (2001). *The Canadian Forces Manual of Drill and Ceremonial*. Ottawa, ON: The Department of National Defence.
8. **Training Aids.** Assistant instructors as required.
9. **Learning Aids.** N/A.
10. **Test Details.** There is no formal assessment of this EO. Instructors will confirm the cadets' ability to perform the movements during the end of lesson check, and ongoing feedback will be provided during future drill practices, weekly parade nights, and ceremonial parades.
11. **Remarks.** N/A.



**COMMON TRAINING
PROFICIENCY LEVEL ONE
INSTRUCTIONAL GUIDE**



SECTION 3

EO M108.03 – EXECUTE TURNS AT THE HALT

Total Time: 15 min

PREPARATION

PRE-LESSON INSTRUCTIONS

A complete list of resources needed for the instruction of this EO is located at Chapter 4 of the QSP. Specific uses for said stores are identified throughout the Instructional Guide, within the teaching point for which they are required.

Prior to instructing this lesson the instructor shall:

- review the lesson content, and become familiar with the material; and
- select the most effective squad formation for the lesson being taught. A squad may be in a single rank, hollow square or semi-circle for elementary drill instruction. (Note: All cadets **must** be able to fully observe all demonstrations and explanations.)

PRE-LESSON ASSIGNMENT

N/A.

APPROACH

This lesson will be presented using the demonstration and performance method. The demonstration and performance method was chosen to allow cadets to participate in supervised exploration of practical instructional material. This method provides the instructor the opportunity to introduce the subject matter, demonstrate and explain procedures, and supervise the cadets while they imitate the skill. This method appeals to all learning styles.



The instructor shall develop and use a vocabulary of short, concise words to impress on the squad that the movements must be performed smartly. For example, the words "crack", "drive", "seize" and "grasp" suggest the degree of smartness required. Profanity or personal sarcasm shall never be used.

INTRODUCTION

REVIEW

N/A.

A-CR-CCP-801/PF-001

OBJECTIVES

By the end of this lesson the cadet shall be expected to execute right turns at the halt.

IMPORTANCE

As members of the Canadian Cadet Movement (CCM) cadets will be required to perform drill movements at a competent level, developing sharpness, esprit de corps, physical coordination, and alertness. These movements will be executed with ease and without hesitation. Ensuring that the cadets efficiently move together as one will promote discipline, alertness, precision, pride, steadiness, and cohesion. This develops the basis of teamwork that the CCM depends on.

Teaching Point 1

Execute Right Turns

Time: 10 min

Method: Demonstration and Performance

DEMONSTRATE THE COMPLETE MOVEMENT WITH TIMING



Instructors are reminded that they are to present the example with regards to drill, from the moment they step onto the parade square. Proper drill movements, combined with a professional demeanour, are of paramount importance, and must be exemplified throughout the period of instruction.

The instructor shall provide a complete demonstration of the drill movement, with timing. A practiced assistant instructor may carry out this demonstration.

The demonstration shall be provided from various vantage points, as required.

Turns and inclines are made to change direction: right or left turns change direction by 90 degrees, about turns by 180 degrees, and right and left inclines (not instructed in this lesson) by 45 degrees.

DEMONSTRATE FIRST PART OF MOVEMENT (FIRST NUMBER)



For ease of instruction, drill commands have been broken down into individual movements, or numbers. The instructor(s) shall demonstrate and explain each number.

The cadet shall execute a right turn, by:

On the command RIGHT TURN BY NUMBERS, SQUAD – ONE, turning 90 degrees to the right by pivoting on the right heel and left toe and raising the left heel and right toe simultaneously. Both knees will be kept braced during the turn, arms at the sides and body erect. On the completion of the movement, the weight of the body is placed on the right foot and the left leg is braced with the heel off the ground.

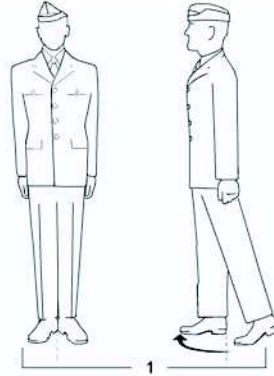

A-PD-201-000/PT-000, The Canadian Forces Manual of Drill and Ceremonial, 2001

Figure 8-3-1 Squad One – Right Turn at the Halt

PRACTICE THE SQUAD ON THE FIRST MOVEMENT

Practice the squad on the first movement collectively, individually and collectively.



Constant checking and correcting of all faults is essential. Faults shall be corrected immediately after they occur.

DEMONSTRATE AND EXPLAIN THE SECOND PART OF THE MOVEMENT

On the command SQUAD – TWO, the cadets shall bend the left knee, straightening it in double time and smartly placing the left foot beside the right to assume the position of attention.

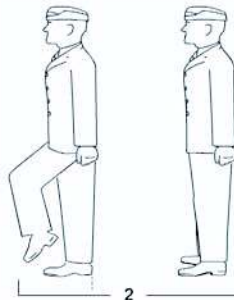

A-PD-201-000/PT-000, The Canadian Forces Manual of Drill and Ceremonial, 2001

Figure 8-3-2 Squad Two – Right Turn at the Halt

PRACTICE THE SQUAD ON THE SECOND MOVEMENT

Practice the squad on the second movement collectively, individually and collectively.

A-CR-CCP-801/PF-001

GIVE TWO COMPLETE AND FINAL DEMONSTRATIONS

On the command RIGHT – TURN, combine the two movements. The standard pause shall be observed between the movements.

The instructor(s) shall provide a full demonstration and allow time for practice.



Standard Pause: The standard pause between each movement is two beats in quick time. For example, on the command MOVE TO THE RIGHT IN FILE, RIGHT – TURN, the squad:

1. executes the first movement of the turn on the executive order and simultaneously calls out “ONE”;
2. after completing the first movement, calls “TWO”, “THREE” while observing the standard pause; and
3. when executing the final movement, calls out “ONE”.

CONFIRMATION OF TEACHING POINT 1

Cadets will execute right turns as a squad.

The cadets' participation in TP1 will serve as the confirmation of this lesson.

CONCLUSION

HOMEWORK/READING/PRACTICE

N/A.

METHOD OF EVALUATION

In accordance with A-PD-201-000/PT-000, *The Canadian Forces Manual of Drill and Ceremonial*, the cadet shall participate in an Annual Ceremonial Review (ACR) parade. This movement will be used in preparation for, and in the execution of, the ACR parade.

CLOSING STATEMENT

The hallmarks of cadet drill are efficiency, precision, and dignity. These qualities are developed through self-discipline and practice. They lead to unit pride and cohesion. Good drill that is well rehearsed, closely supervised and precise, is an exercise in obedience and alertness. It sets the standard for the execution of any duty, both for the individual and the unit, and builds a sense of confidence between commander and subordinate that is essential to high morale. The personal qualities developed on the parade ground must be maintained in all aspects of life.

INSTRUCTOR NOTES/REMARKS

N/A.

REFERENCES

- A0-002 A-PD-201-000/PT-000, DHH 3-2. (2001). *The Canadian Forces Manual of Drill and Ceremonial*. Ottawa, ON: The Department of National Defence.

MODIFIED LESSON INSTRUCTIONS AND INSTRUCTIONAL GUIDES – LEFT TURN AT THE HALT

A-CR-CCP-801/PG-001

EO M108.03 – EXECUTE TURNS AT THE HALT

1. **Performance.** Execute Turns at the Halt.
2. **Conditions**
 - a. Given:
 - (1) words of command;
 - (2) supervision; and
 - (3) assistance as required.
 - b. Denied: N/A.
 - c. Environmental: A drill hall or, in favourable weather, an outdoor parade square.
3. **Standard.** In accordance with A-PD-201-000/PT-000, the cadet shall perform the movement of left turn at the halt.
4. **Teaching Points**

TP	Description	Method	Time	Ref
TP1	Explain and demonstrate the movement of left turn at the halt and allow cadets to practice.	Demonstration and Performance	10 min	A0-002 (pp. 2-12 to 2-13)

5. **Time**
 - a. Introduction/Conclusion: 5 min
 - b. Demonstration and Performance: 10 min
 - c. Total: 15 min
6. **Substantiation.** The demonstration-performance method was chosen to allow cadets to participate in supervised exploration of practical instructional material. This method provides the instructor the opportunity to introduce the subject matter, demonstrate and explain procedures, and supervise the cadets while they imitate the skill. This method appeals to all learning styles.
7. **References.** A0-002 A-PD-201-000/PT-000 DHH 3-2. (2001). *The Canadian Forces Manual of Drill and Ceremonial*. Ottawa, ON: The Department of National Defence.
8. **Training Aids.** Assistant instructors as required.
9. **Learning Aids.** N/A.
10. **Test Details.** There is no formal assessment of this EO. Instructors will confirm the cadets' ability to perform the movements during the end of lesson check, and ongoing feedback will be provided during future drill practices, weekly parade nights, and ceremonial parades.
11. **Remarks.** N/A.



COMMON TRAINING
PROFICIENCY LEVEL ONE
INSTRUCTIONAL GUIDE



SECTION 3

EO M108.03 – EXECUTE TURNS AT THE HALT

Total Time: 15 min

PREPARATION

PRE-LESSON INSTRUCTIONS

A complete list of resources needed for the instruction of this EO is located at Chapter 4 of the QSP. Specific uses for said stores are identified throughout the Instructional Guide, within the teaching point for which they are required.

Prior to instructing this lesson the instructor shall:

- review the lesson content, and become familiar with the material; and
- select the most effective squad formation for the lesson being taught. A squad may be in a single rank, hollow square or semi-circle for elementary drill instruction. (Note: All cadets **must** be able to fully observe all demonstrations and explanations.)

PRE-LESSON ASSIGNMENT

N/A.

APPROACH

This lesson will be presented using the demonstration and performance method. The demonstration and performance method was chosen to allow cadets to participate in supervised exploration of practical instructional material. This method provides the instructor the opportunity to introduce the subject matter, demonstrate and explain procedures, and supervise the cadets while they imitate the skill. This method appeals to all learning styles.



The instructor shall develop and use a vocabulary of short, concise words to impress on the squad that the movements must be performed smartly. For example, the words "crack", "drive", "seize" and "grasp" suggest the degree of smartness required. Profanity or personal sarcasm shall never be used.

INTRODUCTION

REVIEW

N/A.

A-CR-CCP-801/PF-001

OBJECTIVES

By the end of this lesson the cadet shall be expected to execute turns at the halt.

IMPORTANCE

As members of the Canadian Cadet Movement (CCM) cadets will be required to perform drill movements at a competent level, developing sharpness, esprit de corps, physical coordination, and alertness. These movements will be executed with ease and without hesitation. Ensuring that the cadets efficiently move together as one will promote discipline, alertness, precision, pride, steadiness, and cohesion. This develops the basis of teamwork that the CCM depends on.

Teaching Point 1

Execute Left Turns

Time: 10 min

Method: Demonstration and Performance

DEMONSTRATE THE COMPLETE MOVEMENT WITH TIMING



Instructors are reminded that they are to present the example with regards to drill, from the moment they step onto the parade square. Proper drill movements, combined with a professional demeanour, are of paramount importance, and must be exemplified throughout the period of instruction.

The instructor shall provide a complete demonstration of the drill movement, with timing. A practiced assistant instructor may carry out this demonstration.

The demonstration shall be provided from various vantage points, as required.

Turns and inclines are made to change direction: right or left turns change direction by 90 degrees, about turns by 180 degrees, and right and left inclines (not instructed in this lesson) by 45 degrees.

DEMONSTRATE FIRST PART OF MOVEMENT (FIRST NUMBER)



For ease of instruction, drill commands have been broken down into individual movements, or numbers. The instructor(s) shall demonstrate and explain each number

The cadet shall execute a left turn, by:

On the command LEFT TURN BY NUMBERS, SQUAD – ONE, turning 90 degrees to the left by pivoting on the left heel and right toe and raising the right heel and left toe simultaneously. Both knees will be kept braced during the turn, arms at the sides and body erect. On the completion of the movement, the weight of the body is placed on the left foot and the right leg is braced with the heel off the ground.

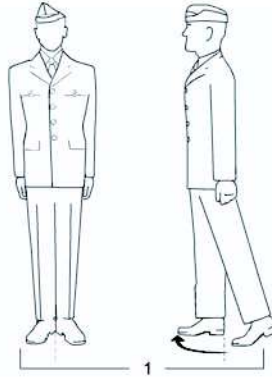

A-PD-201-000/PT-000, The Canadian Forces Manual of Drill and Ceremonial, 2001

Figure 8-3-1 Squad One – Turn at the Halt

PRACTICE THE SQUAD ON THE FIRST MOVEMENT

Practice the squad on the first movement collectively, individually and collectively.



Constant checking and correcting of all faults is essential. Faults shall be corrected immediately after they occur.

DEMONSTRATE AND EXPLAIN THE SECOND PART OF THE MOVEMENT (SECOND NUMBER)

On the command SQUAD – TWO, bend the right knee, straightening it in double time and smartly placing the right foot beside the left to assume the position of attention.

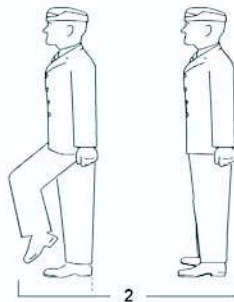

A-PD-201-000/PT-000, The Canadian Forces Manual of Drill and Ceremonial, 2001

Figure 8-3-2 Squad Two – Turn at the Halt

PRACTICE THE SQUAD ON THE SECOND MOVEMENT

Practice the squad on the second movement collectively, individually and collectively.

A-CR-CCP-801/PF-001

GIVE TWO COMPLETE AND FINAL DEMONSTRATIONS

On the command LEFT – TURN, combine the two movements. The standard pause shall be observed between the movements.

The instructor(s) shall provide a full demonstration and allow time for practice.



Standard Pause: The standard pause between each movement is two beats in quick time. For example, on the command MOVE TO THE LEFT IN FILE, LEFT – TURN, the squad:

1. Executes the first movement of the turn on the executive order and simultaneously calls out "ONE".
2. After completing the first movement, calls "TWO", "THREE" while observing the standard pause.
3. When executing the final movement, calls out "ONE".

CONFIRMATION OF TEACHING POINT 1

Cadets will execute LEFT turns as a squad.

END OF LESSON CONFIRMATION

The cadets' participation in TP1 will serve as the confirmation of this lesson

CONCLUSION

HOMEWORK/READING/PRACTICE

N/A.

METHOD OF EVALUATION

In accordance with A-PD-201-000/PT-000, *The Canadian Forces Manual of Drill and Ceremonial*, the cadet shall participate in an Annual Ceremonial Review (ACR) parade. This movement will be used in preparation for, and in the execution of, the ACR parade.

CLOSING STATEMENT

The hallmarks of cadet drill are efficiency, precision, and dignity. These qualities are developed through self-discipline and practice. They lead to unit pride and cohesion. Good drill that is well rehearsed, closely supervised and precise, is an exercise in obedience and alertness. It sets the standard for the execution of any duty, both for the individual and the unit, and builds a sense of confidence between commander and subordinate that is essential to high morale. The personal qualities developed on the parade ground must be maintained in all aspects of life.

INSTRUCTOR NOTES/REMARKS

N/A.

REFERENCES

- A0-002 A-PD-201-000/PT-000, DHH 3-2. (2001). *The Canadian Forces Manual of Drill and Ceremonial*. Ottawa, ON: The Department of National Defence.

MODIFIED LESSON INSTRUCTIONS AND INSTRUCTIONAL GUIDES – ABOUT TURN AT THE HALT

A-CR-CCP-801/PG-001

EO M108.03 – EXECUTE TURNS AT THE HALT

1. **Performance.** Execute Turns at the Halt.
2. **Conditions**
 - a. Given:
 - (1) words of command;
 - (2) supervision; and
 - (3) assistance as required.
 - b. Denied: N/A.
 - c. Environmental: A drill hall or, in favourable weather, an outdoor parade square.
3. **Standard.** In accordance with A-PD-201-000/PT-000, the cadet shall perform the movement of about turn at the halt.
4. **Teaching Points**

TP	Description	Method	Time	Ref
TP1	Explain and demonstrate the movement of about turn at the halt and allow cadets to practice.	Demonstration and Performance	10 min	A0-002 (pp. 2-12 to 2-13)

5. **Time**
 - a. Introduction/Conclusion: 5 min
 - b. Demonstration and Performance: 10 min
 - c. Total: 15 min
6. **Substantiation.** The demonstration-performance method was chosen to allow cadets to participate in supervised exploration of practical instructional material. This method provides the instructor the opportunity to introduce the subject matter, demonstrate and explain procedures, and supervise the cadets while they imitate the skill. This method appeals to all learning styles.
7. **References.** A0-002 A-PD-201-000/PT-000 DHH 3-2. (2001). *The Canadian Forces Manual of Drill and Ceremonial*. Ottawa, ON: The Department of National Defence.
8. **Training Aids.** Assistant instructors as required.
9. **Learning Aids.** N/A.
10. **Test Details.** There is no formal assessment of this EO. Instructors will confirm the cadets' ability to perform the movements during the end of lesson check, and ongoing feedback will be provided during future drill practices, weekly parade nights, and ceremonial parades.
11. **Remarks.** N/A.



COMMON TRAINING
PROFICIENCY LEVEL ONE
INSTRUCTIONAL GUIDE



SECTION 3

EO M108.03 – EXECUTE TURNS AT THE HALT

Total Time: 15 min

PREPARATION

PRE-LESSON INSTRUCTIONS

A complete list of resources needed for the instruction of this EO is located at Chapter 4 of the QSP. Specific uses for said stores are identified throughout the Instructional Guide, within the teaching point for which they are required.

Prior to instructing this lesson the instructor shall:

- review the lesson content, and become familiar with the material; and
- select the most effective squad formation for the lesson being taught. A squad may be in a single rank, hollow square or semi-circle for elementary drill instruction. (Note: All cadets **must** be able to fully observe all demonstrations and explanations.)

PRE-LESSON ASSIGNMENT

N/A.

APPROACH

This lesson will be presented using the demonstration and performance method. The demonstration and performance method was chosen to allow cadets to participate in supervised exploration of practical instructional material. This method provides the instructor the opportunity to introduce the subject matter, demonstrate and explain procedures, and supervise the cadets while they imitate the skill. This method appeals to all learning styles.



The instructor shall develop and use a vocabulary of short, concise words to impress on the squad that the movements must be performed smartly. For example, the words "crack", "drive", "seize" and "grasp" suggest the degree of smartness required. Profanity or personal sarcasm shall never be used.

INTRODUCTION

REVIEW

N/A.

A-CR-CCP-801/PF-001

OBJECTIVES

By the end of this lesson the cadet shall be expected to execute turns at the halt.

IMPORTANCE

As members of the Canadian Cadet Movement (CCM) cadets will be required to perform drill movements at a competent level, developing sharpness, esprit de corps, physical coordination, and alertness. These movements will be executed with ease and without hesitation. Ensuring that the cadets efficiently move together as one will promote discipline, alertness, precision, pride, steadiness, and cohesion. This develops the basis of teamwork that the CCM depends on.

Teaching Point 1

Execute About Turns

Time: 10 min

Method: Demonstration and Performance

DEMONSTRATE THE COMPLETE MOVEMENT WITH TIMING



Instructors are reminded that they are to present the example with regards to drill, from the moment they step onto the parade square. Proper drill movements, combined with a professional demeanour, are of paramount importance, and must be exemplified throughout the period of instruction.

The instructor shall provide a complete demonstration of the drill movement, with timing. A practiced assistant instructor may carry out this demonstration.

The demonstration shall be provided from various vantage points, as required.

DEMONSTRATE FIRST PART OF MOVEMENT (FIRST NUMBER)

On the command ABOUT TURN BY NUMBERS, SQUAD – ONE, turning 180 degrees to the right by pivoting on the right heel and left toe and raising the left heel and right toe simultaneously. Both knees will be kept braced during the turn, arms at the sides and body erect. On the completion of the movement, the weight of the body is placed on the right foot and the left leg is braced with the heel off the ground.

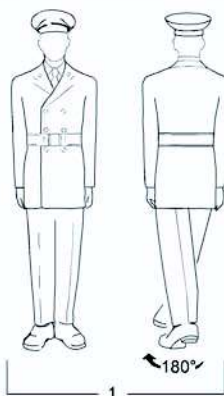

A-PD-201-000/PT-000, *The Canadian Forces Manual of Drill and Ceremonial*, 2001

Figure 8-3-3 Squad One – About Turn at the Halt

PRACTICE THE SQUAD ON THE FIRST MOVEMENT

Practice the squad on the first movement collectively, individually and collectively.



Constant checking and correcting of all faults is essential. Faults shall be corrected immediately after they occur.

DEMONSTRATE AND EXPLAIN THE SECOND PART OF THE MOVEMENT

On the command SQUAD – TWO, bending the left knee, straightening it in double time and smartly placing the left foot beside the right to assume the position of attention.

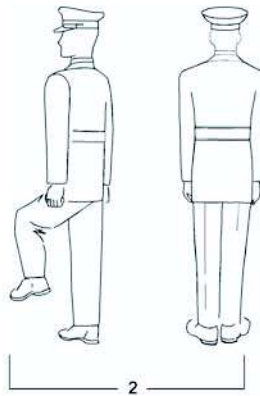

A-PD-201-000/PT-000, The Canadian Forces Manual of Drill and Ceremonial, 2001

Figure 8-3-4 Squad Two – About Turn at the Halt

PRACTICE THE SQUAD ON THE SECOND MOVEMENT

Practice the squad on the second movement collectively, individually and collectively.

GIVE TWO COMPLETE AND FINAL DEMONSTRATIONS

On the command ABOUT – TURN, combine the two movements. The standard pause shall be observed between the movements.

The instructor(s) shall provide a full demonstration and allow time for practice.

A-CR-CCP-801/PF-001



Standard Pause: The standard pause between each movement is two beats in quick time. For example, on the command ABOUT – TURN, combine the two movements. The standard pause shall be observed between the movements:

1. Executes the first movement of the turn on the executive order and simultaneously calls out "ONE".
2. After completing the first movement, calls "TWO", "THREE" while observing the standard pause.
3. When executing the final movement, calls out "ONE".

CONFIRMATION OF TEACHING POINT 1

Cadets will execute about turns as a squad.

END OF LESSON CONFIRMATION

The cadets' participation in TP1 will serve as the confirmation of this lesson

CONCLUSION

HOMEWORK/READING/PRACTICE

N/A.

METHOD OF EVALUATION

In accordance with A-PD-201-000/PT-000, *The Canadian Forces Manual of Drill and Ceremonial*, the cadet shall participate in an Annual Ceremonial Review (ACR) parade. This movement will be used in preparation for, and in the execution of, the ACR parade.

CLOSING STATEMENT

The hallmarks of cadet drill are efficiency, precision, and dignity. These qualities are developed through self-discipline and practice. They lead to unit pride and cohesion. Good drill that is well rehearsed, closely supervised and precise, is an exercise in obedience and alertness. It sets the standard for the execution of any duty, both for the individual and the unit, and builds a sense of confidence between commander and subordinate that is essential to high morale. The personal qualities developed on the parade ground must be maintained in all aspects of life.

INSTRUCTOR NOTES/REMARKS

N/A.

REFERENCES

A0-002 A-PD-201-000/PT-000, DHH 3-2. (2001). *The Canadian Forces Manual of Drill and Ceremonial*. Ottawa, ON: The Department of National Defence.

THIS PAGE INTENTIONALLY LEFT BLANK

DRILL INSTRUCTIONAL TECHNIQUES – ASSESSMENT FORM

Cadet's Name: _____

Flight: _____

Lesson Topic: _____

CRITERIA	COMMENTS	Incomplete	Completed /ith Difficulty	Completed Without Difficulty
PREPARATION				
Maintained dress and deportment.				
Selected an appropriate squad formation.				
Used a lesson plan.				
Reviewed previous lesson.				
INTRODUCTION				
Stated what the cadets will learn.				
Stated why it is important.				
Stated where/when this skill will be applied.				
BODY				
Demonstrated complete movement, calling the time.				
Demonstrated and explained the first part of the movement (Squad 1).				
Had the squad practice the first part of the movement collectively, individually and collectively again.				
Taught the second part of the movement and each subsequent part in the same manner.				
Gave two complete demonstrations.				

CRITERIA	COMMENTS	Incomplete	Completed with Difficulty	Completed Without Difficulty
Practiced the complete movement with: <ul style="list-style-type: none"> • the instructor calling the time, • the cadets calling the time, and • the cadets judging the time. 				
Used clear words of command and correct pauses.				
Gave appropriate and immediate feedback.				
Allowed questions after each movement.				
END OF LESSON CONFIRMATION				
Demonstrated the movement taught.				
Confirmation was conducted as a squad.				
Emphasized aspects of the movement with which the cadets experienced difficulty.				
CONCLUSION				
Summarized the lesson.				
Re-motivated the cadets.				
FEEDBACK				

 Assessor's Signature

 Date

 Cadet's Signature